



aerospace  
climate control  
electromechanical  
filtration  
fluid & gas handling  
hydraulics  
pneumatics  
process control  
sealing & shielding



# Thermoplastic Hoses for Ultra High Pressure

Catalogue 4462 Global Edition



ENGINEERING YOUR SUCCESS.



**Introduction and General Statements**

*How to use the catalog* ..... II  
*Part number system* ..... IV  
*Explanation of symbols* ..... V  
*User Manual for the Application of Hose Assemblies* ..... VI  
*Polyflex Division* ..... XII  
*Why use Parker thermoplastic hose?* ..... XIII  
*Value added services* ..... XIX



**Hose and Fitting Selection**

*Hose selection chart by working pressure – design factor >2:1* ..... A – 2  
*Hose selection chart by working pressure – design factor 4:1* ..... A – 4  
*Hose fitting chart* ..... A – 5



**Hoses with design factor 4:1**



**Hoses with design factor >2:1**



**Polyflex-Lok**

*Polyflex-Lok components* ..... D – 2



**Connectors & Adapters – Valves**

*High Pressure Connectors & Adapters* ..... E – 4  
*Valves* ..... E – 40



**Accessories**

*Heavy duty abrasion cover* ..... F – 2  
*Heavy duty abrasion cover sleeves* ..... F – 2  
*Spring guards* ..... F – 3  
*Support grips* ..... F – 3  
*PVC-S – Anti-abrasion sleeve* ..... F – 4  
*HS – Containment grips* ..... F – 4  
*UHPLABEL – Precautions for ultra-high pressure applications* ..... F – 4

**G**

**Technical Information**

<i>Installation tips</i> .....	G - 2
<i>Selection, installation, and maintenance of polyflex hose</i> .....	G - 3
<i>Dash sizes</i> .....	G - 4
<i>Selection of hose diameter from flow rate and velocity</i> .....	G - 5
<i>Pressure drop</i> .....	G - 6
<i>Glossary</i> .....	G - 11
<i>Permeability coefficient</i> .....	G - 12
<i>Recommended tightening procedures</i> .....	G - 13
<i>Metric conversion chart</i> .....	G - 14
<i>General chemical resistance table</i> .....	G - 15
<i>Parker Safety Guide</i> .....	G - 20

**H**

**Index of Part Numbers**

<i>Index</i> .....	H - 1
<i>Safety note</i> .....	H - 16

The content contained in this catalogue has been compiled with the greatest care and corresponds to the information currently available to us.

However, we would like to point out that we reserve the right to make technical changes and we kindly request you to contact us should you have any special questions.

## How to use the catalogue

Overall structure of the catalogue:

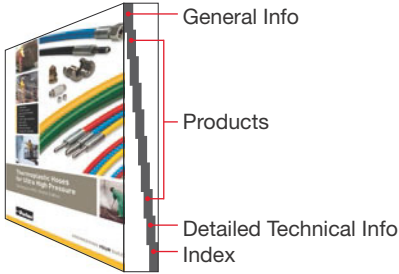

Hoses with safety factor 2.5:1  
2440D / 2440N

**2440D / 2440N – Ultra-high pressure hose**

Core tube : DN 3-8: Polyoxymethylene; DN 10-25: Polyamide  
Pressure reinforcement : Four spiral layers of maximum tensile steel wire  
Cover : Polyamide  
Standard colour : DN 3-8: blue; DN 10-25: black

CONSTRUCTION

TEMPERATURE RANGE -10°C up to +70°C

Safety Factor 2.5:1

#	DN		inches		MPa		psi		lbm		
	mm	inches	mm	inches	mm	psi	mm	lbm	mm	lbm	
2440D-02V32	3	-02	3.0	1/8	7.9	207	30,000	518	75,000	100	6.12
2440D-025V32	4	-025	4.0	5/32	10.4	220	31,900	550	79,750	100	6.21
2440D-03V32	5	-03	4.8	3/16	11.5	180	26,100	450	65,250	130	0.28
2440D-04V32	6	-04	5.4	1/4	12.5	164	23,780	410	59,450	155	0.33
2440D-05V32	8	-05	8.1	5/16	15.1	150	21,750	375	54,375	175	0.44
2440N-06V30	10	-06	9.7	3/8	19.4	140	20,300	350	50,750	190	0.73
2440N-08V30	12	-08	12.6	1/2	22.5	130	18,850	325	47,125	200	0.94
2440N-12V30	20	-12	19.6	3/4	30.0	100	14,500	250	35,250	250	1.39
2440N-16V30	26	-16	25.6	1	37.0	90	13,050	225	32,625	300	2.00

NOTES -

Parker

C-36

Catalogue 4462 Global Edition

Hose data is always colored in blue

Chapter selector  
if you know the chapter you are looking for  
– this is the quickest way to get there



Shows the current chapter

1AYLX – Type “M” female swivel

Hoses with safety factor 2.5:1  
6AYLX / 1AYLX

MATERIAL High strength carbon steel, zinc plated

#	DN	size	mm	inch	9/16 - 18UNF	A		B	J	MPa	psi	Nipple		Ferrule	
						mm	inch					mm	inch	mm	inch
1AYLX-6-02	3	-025	3.0	1/8	9/16 - 18UNF	43	25	22	220	30,000	1.5	9.8	??	??	
1AYLX-6-025	4	-025	4.0	5/32	9/16 - 18UNF	54	33	22	220	21,900	1.4	14.6	??	??	
1AYLX-6-03	5	-03	4.8	3/16	9/16 - 18UNF	55	33	22	220	20,100	1.4	15.3	??	??	
1AYLX-6-04	6	-04	5.4	1/4	9/16 - 18UNF	51	29	22	180	20,100	1.4	15.3	??	??	
1AYLX-8-05	8	-05	7.9	5/16	3/4 - 16UNF	76	39	22	164	20,300	3.9	17.0	??	??	
1AYLX-8-06	10	-06	9.5	3/8	3/4 - 16UNF	70	28	27	150	21,750	3.7	21.0	??	??	
1AYLX-11-08	12	-08	12.7	1/2	1 - 12 UNF	80	27	32	140	20,300	5.8	26.9	??	??	
1AYLX-16-12	20	-12	19.0	3/4	1 5/16-12UNF	82	29	41	100	14,500	12.7	38.5	??	??	

6AYLX / 1AYLX – Type “M” female swivel

MATERIAL Stainless steel

#	DN	size	mm	inch	9/16 - 18 UNF	A		B	J	MPa	psi	Nipple		Ferrule	
						mm	inch					mm	inch	mm	inch
6AYLX-6-2AC	4	-025	4.0	5/32	9/16 - 18 UNF	54	33	17	220	31,900	??	??	??	??	
1AYLX-6-03C	5	-03	4.8	3/16	9/16 - 18 UNF	57	29	22	180	26,100	1.4	15.3	??	??	
1AYLX-6-04C	6	-04	5.4	1/4	9/16 - 18UNF	51	29	22	154	23,780	2.9	17.0	??	??	
1AYLX-8-05C	8	-05	7.9	5/16	3/4 - 16 UNF	70	31	27	150	21,750	3.7	21.0	??	??	
1AYLX-8-06C	10	-06	9.5	3/8	3/4 - 16 UNF	70	25	27	140	20,300	5.8	26.9	??	??	
1AYLX-11-08C	12	-08	12.7	1/2	1 - 12 UNF	80	27	32	130	18,850	6.7	30.7	??	??	
1AYLX-16-12C4462	20	-12	19.0	3/4	1 5/16-12 UNF	82	29	41	100	14,500	12.7	38.5	??	??	
6AYLX-16-16C	25	-15	25.4	1	1 5/16 - 12 UNF	100	47	38	90	13,050	17.2	45.3	??	??	

Category selector  
– superordinates chapters  
into product groups



## Part number system

## Hoses



**2440 N - 16 V91**



## Fittings

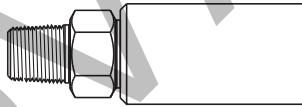

**6 01 LX - 8 - 8 C**

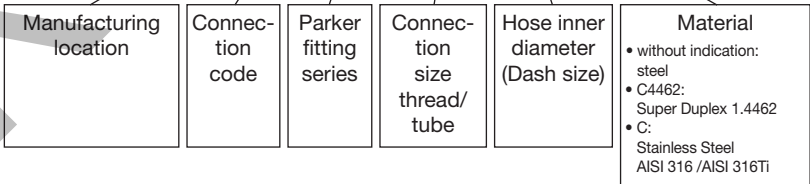



## Explanation of symbols

Symbol	Description
#	Part number
	Nominal inner diameter
	Nominal outer diameter
	Working pressure
	Burst pressure
	Bend radius
	Weight
	Fittings
	Thread size
	Wrench size
	Thickness

# User Manual for the Application of Hose Assemblies for High-Pressure Water Jet Machines

This User Manual has been prepared according to the requirements of EN 1829-2: 2008 High-Pressure Water Jet machines – Safety Requirements – Part 2: Hoses, Hose Lines and Connectors. It contains instructions on the proper use of hose assemblies made by Parker Hannifin GmbH, Polyflex Division, for high pressure water-jetting applications. Never use hose assemblies without thoroughly reading and understanding this User Manual. Any additional safety requirements issued by machine manufacturers, trade associations etc. must be complied with. We recommend wearing protective clothing.

1. Hazard notice
2. Description
3. Marking
4. Assembly and installation, proper use
5. Storage and utilization time of hose assemblies
6. Maintenance, repair, inspection, periodic pressure tests

## 1. Hazard notice

### Hazards due to escaping media

- Media escaping at high pressure can cause personal injury and property damage.
- The escape of flammable media can cause fire.
- The escape of toxic media can cause intoxication if these are inhaled or ingested.

### Hazards because of whipping hose assemblies

- If after break of the hose assembly the pressure is not immediately reduced to zero, the hose starts whipping, which may cause personal injury or property damage.

### Hazards due to change in length of the hose assembly

- In the event of a sudden pressure change in the hose assembly, its length may change by  $\pm 2\%$ . This may lead to the operators losing their safe foothold.

### Hazards due to incorrect behavior of operator

- Hazards may arise from the use of unsuitable substances or components by the operator, especially in case the application limits defined by the manufacturer are exceeded (e.g. too high pressure, too high tensile loads).

## 2. Description

The hose assemblies are made from high-pressure hose and the corresponding fittings by Parker Polyflex and the company's trained and certified distributors in compliance with Parker assembly instructions. They are pressure tested after completion. Upon customer's request, the hose assemblies can be equipped with protective sleeves or other safety equipment such as containment grips.



### 3. Marking

- The hose bears a factory marking specifying the manufacturer, the maximum working pressure, the part number, nominal size, batch number and the date of manufacture (quarter/year). The marking may include additional information.
- Protective sleeve has no marking as a standard.
- On its crimping shell or marking sleeve, the hose assembly bears a marking specifying the manufacturer, the maximum working pressure, the month and year of manufacture and the standard "EN 1829-2".

The working pressures of both hoses and fittings are limited. In rare cases, fittings with a lower working pressure than the hose may be used. In this case the hose assembly bears an additional warning. For the application of the hose assembly, it is not the pressure stated on the hose but the pressure on the crimping shell and/or marking sleeve that is relevant.

### 4. Assembly and installation, proper use

#### Assembly and installation

To ensure the proper function of hose assemblies and in order not to shorten their life by additional strain, the following instructions need to be followed:

- The maximum working pressure shall not be exceeded.
- The hose shall not be bent to less than its minimum bend radius.
- Do not kink or twist hose assemblies. Especially when long hose assemblies are routed, loops may form which can lead to kinks in the hose when pulled. Parker manufactures special fittings (Polyflex-Lok) which minimize this problem.
- Under pressure, any hose may become shorter or longer. Change in length of Parker hoses is in the range of approx. 2%.
- Before installing a hose assembly, make a visual inspection of the following:
  - o The working pressure of the hose assembly corresponds to the pressure of the pump.
  - o The hose cover does not show any damage.
  - o The fittings do not show any signs of corrosion.
  - o Threads and sealing faces are not damaged or dirty.
  - o O-rings are available and not damaged.
- Make sure that the connecting thread of the fitting matches its counter-piece.
- Do not remove protective caps until immediately prior to assembly.
- When mounting the fitting, slightly grease the threads of the fitting and the adapter to prevent cold welding (seizing).

When putting the hose assembly into operation, slowly build up the pressure and check the assemblies for leaks.

#### Proper use

Operating medium: Parker High Pressure hose assemblies are designed for use with water. For information about use with other media, please contact your Parker distributor – Parker's range includes special hoses which are suitable for e.g. corrosive media.

**Temperature:** The hose assemblies are designed for safe operation at temperatures from -10 to +70°C. If you wish to operate the hose assembly beyond this range, please contact your Parker distributor. Parker's range also includes special hoses suitable for higher temperatures. If hose assemblies are operated at low temperatures, no problems should be expected with the hose assemblies themselves; however, measures should be taken to prevent the operating medium from freezing.

**Trouble-shooting:** Immediately eliminate any leakage on the connectors (refasten connectors, replace O-rings, if necessary, or rework the cone).

**Caution:** Prior to performing any work, always relieve the pressure – never work on hose assemblies while they are under pressure. Should the leakage occur in the hose (blisters in the hose cover, leaks at the relief holes of the fitting) put the hose assembly out of operation immediately.

Continued use of a leaky hose assembly exposes the operators to serious hazards.

**Special types of application:** When used in tall buildings, hose assemblies have to be supported to prevent tensile stress. If hose assemblies are used under tensile stress, this will shorten their life.

When using hose assemblies in potentially explosive atmospheres, it needs to be considered that Parker high-pressure hose assemblies are electrically conductive in general (from fitting to fitting). However, neither the protective sleeves nor the hose cover are electrically conductive.

## 5. Storage and utilization time of hose assemblies

---

Even if properly stored and operated at permissible loads, hose assemblies are subject to natural ageing. This limits their storage and utilization time. Improper storage, mechanical damage and excessive stress are the most frequent causes of failure.

For the storage of hose assemblies, the following instructions shall be followed:

- Store the hose assemblies in a cool and dry place with low levels of dust.
- Do not expose the hose assemblies to direct sunlight or UV radiation.
- Protect the hose assemblies from heat sources.
- Do not use any ozone-generating luminaries (fluorescent sources of light, mercury vapor lamps) or electrical devices in the immediate vicinity of hose assemblies.
- Store hose assemblies stress-free and in a horizontal position.
- When storing hose assemblies in bundles, the hose shall not be bent to less than its minimum bend radius.
- Store fittings with protective caps to prevent damage to the thread.

The maximum storage time of bulk hose is 10 years and that of completed hose assemblies is up to 2 years. If possible, storage of hose assemblies should be avoided. The natural properties of the hose materials cause a loss of compression in the fitting, which may lead to premature leakage of the fitting.

### Utilization period and replacement intervals

Parker does not limit the utilization period of a hose assembly, however it should not exceed 6 years.

Hose assemblies are used in a great variety of applications. For this reason Parker Polyflex is unable to guarantee a specific useful life of the hose assembly in a particular application.

The following guidelines may be useful:

- a) Parker Polyflex hose assemblies meet, or in most cases, exceed the requirements of DIN EN 1829-2. This standard prescribes that hose assemblies have to resist at least 20,000 cycles from zero to working pressure. This is relevant for industrial applications (e.g. cleaning of parts in the automotive industry) where hose assemblies are used on a permanent basis. In this case, no periodic pressure tests are required, but periodic visual inspections are recommended. The intervals for visual inspection and replacement must be determined by the manufacturer of the plant.
- b) In the construction industry (e.g. concrete refurbishment) and in flexible guns, hose assemblies are usually exposed to additional stress (e.g. tensile loads, mechanical damage) which may considerably reduce their useful life. Therefore the tests according to Section 6 are mandatory.

## 6. Maintenance, repair, inspection, periodic pressure tests

Prior to the first putting into operation and at least every six months:

Check the hose assemblies for their function and as to whether they can be safely used. This inspection should be done by a skilled person, who due to professional training and experience has sufficient knowledge about hoses.

Scope of tests: visual inspection of the hose assemblies. Check whether the working pressure of the hose assembly corresponds to the actual working pressure of the application and whether the hose assembly shows any visible damage. Visible damage may include:

- Damage of the hose cover (e.g. abrasion, cuts or cracks).
- Deformation beyond the natural shape of the hose assembly in depressurized or pressurized state or during bending. This may include separation of layers, blisters, crushed or kinked hose.
- Damage or deformation of the fitting.
- Corroded fitting.
- Hose detaching from the fitting.
- Maximum storage and utilization times have been exceeded.

Daily:

- Visual inspection of the hose assemblies by the operator (see above)

Upon discovery of any visible damage, replace the hose assembly or have it approved for further use by a qualified person.

According to EN 1829-2 hose assemblies whose cover is so badly damaged that the wire reinforcement becomes visible have to be withdrawn from service. Repair of the hose cover is not allowed.

Yearly:

In addition to the visual inspection of the hose assembly, a pressure test with 1.2 x the working pressure has to be performed with this pressure being applied for two minutes. This pressure test is not required for hose assemblies in continuous use (industrial plants).

Repair of hose assemblies

Parker Polyflex advises against the repair of hose assemblies as the safety of a hose assembly that has already been in service is always reduced.

In general, repair of hose assemblies by authorized Parker Polyflex distributors is permissible with certain restrictions. Please consult your Parker distributor.

## 7. Polyflex-Lok

Polyflex-Lok is a system designed for the fast mounting of hose assemblies and/or for the connection of the hose assemblies to the pump / gun without any tools.

The system for connecting hose assemblies consists of hose assemblies (equipped with protective sleeve as a standard) with special connectors and protective caps, connection sleeves and shells.

### Assembly:

Remove the protective caps from the hose connectors.

Slightly grease the hose connectors or wet them with some water and push them into the connection sleeve up to the stop. **CAUTION:** Make sure that all parts are perfectly clean and free from dirt and damage or deposits. Otherwise proper tightness and/or easy disassembly cannot be ensured. If necessary, clean the parts prior to assembly.

Close the shells over the connection sleeve.

Pull the hose assemblies apart (important, as otherwise the protective caps cannot be mounted) and mount the protective caps between the shells and the clamping sleeves for the protective sleeve.

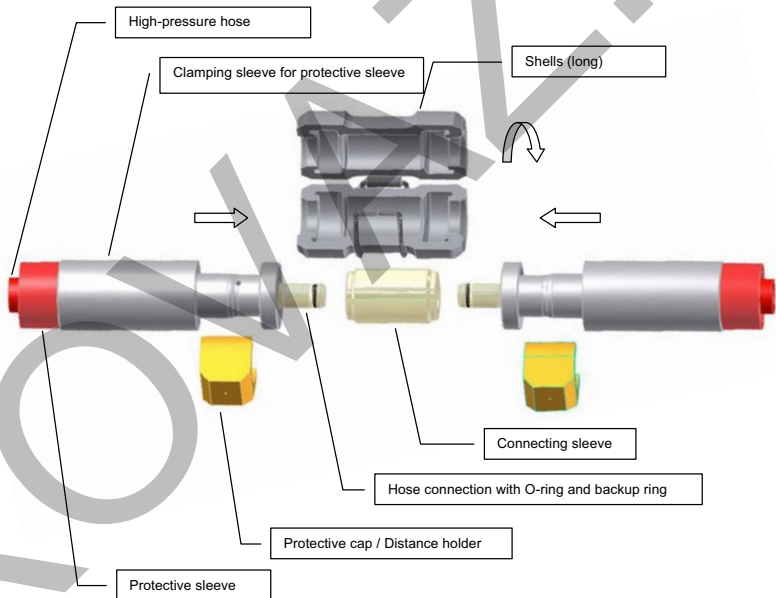



Disassembly:

Remove the protective caps.

Push the hose assemblies together up to the stop as otherwise the shells cannot be opened.

Open the shells and remove them.

Pull the hose connectors out of the connecting sleeve and immediately place the protective caps on the hose connectors.

The Polyflex-Lok system for the connection of the hose assembly to the pump / gun is designed according to the same principle. An adaptor is screwed onto the pump; a hose assembly is pushed into the adaptor and fixed with shells and a cap. Here as well cleanliness is mandatory.

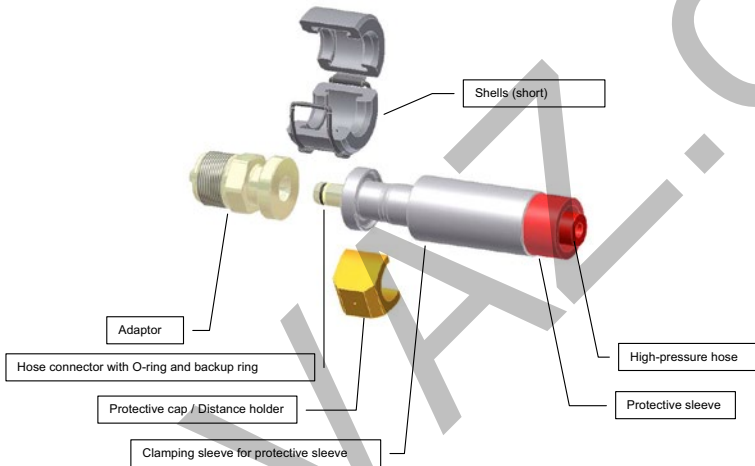

## Parker Hannifin – Polyflex Division

Parker Hannifin offers an extensive programme of systems and components for fluid technology. Parker is structured by sales offices and manufacturing divisions to guarantee optimum focus on our customers' demands and market interests at any time.

The Polyflex division, with headquarters located in Hüttenfeld, Germany, provides thermoplastic hoses and tubes. These are applied in a variety of different markets such as standard hydraulics, ultra high pressure applications, and oil & gas industry. As a market leader in many areas and with a unique product range we are pleased to assist you with all your queries.

This catalogue includes hoses for high and ultra high pressure applications. The indicated fittings are always adapted to the correspondent hose and offer optimum performance.

### Other catalogues with thermoplastic hoses

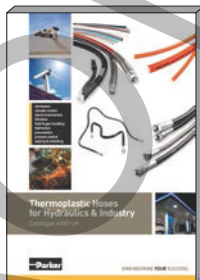

Catalogue 4460-UK

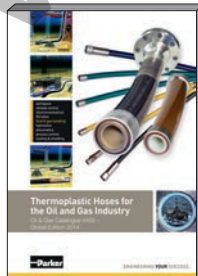

Catalogue 4465-UK

## Why use Parker thermoplastic hoses?

Parker thermoplastic hose is the right answer for many technical challenges. With unique features and performance characteristics thermoplastic hose outperforms even established alternatives. Whether the task requires extreme temperatures, pressures, robustness or special custom designs, these hoses will not disappoint you.

See below the benefits offered by our complete hose range – also products featured in other catalogs – shown in comparison to other standard hose types :

### Temperature Range

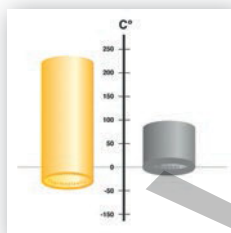

- Operating temperatures ranging from  $-50^{\circ}\text{C}$  up to  $+230^{\circ}\text{C}$
- Best choice for dynamic applications even at very low temperatures
- Full working pressure even at extreme temperatures



### Chemical Resistance



- Chemically inert, no interaction with the media
- Resistant against virtually all acids and alkalines



## Abrasion



- Outer covers to withstand extreme wear
- Superior resistance and extended service life

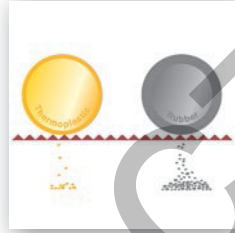

## UV / Ozone & Seawater Resistance



- Build for harsh and exposed installations
- Environmental influences have minimal effect on hose life



## Compact OD



- Space saving due to very small diameters
- Optimized routing and design in constricted installation spaces
- Prevent using overdimensioned hoses

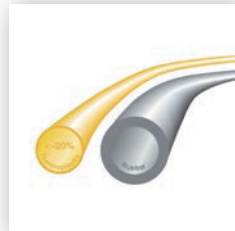



## Small ID



- Only thermoplastic hoses allow small IDs down to below 2mm
- Space saving
- Offers improved technical solutions in constricted installation spaces

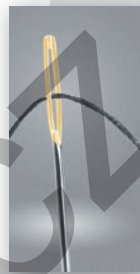

## Low Weight



- Major weight savings
- Energy savings as less mass needs to be moved



## Non-Conductive



- Mandatory safety feature for applications with high voltage and high frequency
- Electrically isolating according to SAE J517



## Customization

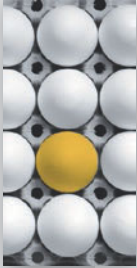

- Multiple colors
- Twin and multiple lines
- Hose bundles
- Customer specific designs

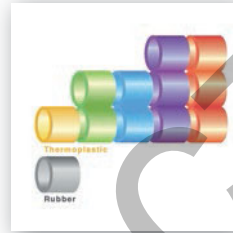

## Preforming



- Combining the advantages of bent metal pipe with the flexibility of hose
- Reducing weight, noise and vibration compared to bent metal pipe solutions
- Preformed hoses are maintaining their full technical specifications



## Cleanliness



- Less abrasion and contamination inside the hose
- Reduced residue build up
- Extended lifetime for filters, valves and hydraulic systems





### Permeation Resistance

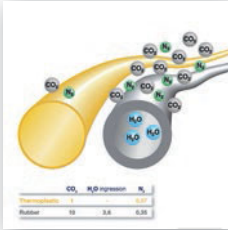

- Low gas permeation
- Reduced ingress reduced risk of media contamination

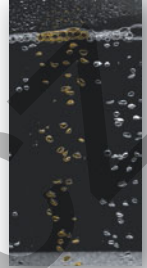

### Long Length



- Up to 5,000 m and more continuous length
- Reduced scrap of bulk hose
- Easy winching and handling offer fast deployment of long length

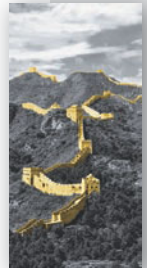

### Highest Pressure



- Up to 4,000 bar working pressure
- Highest technical standards and production controls assure safety

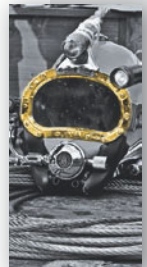

## Wide range of applications



- Standard hydraulics
- Industrial hydraulics e.g.
  - alternative energies
  - machine tools
  - injection molding
- Mobile hydraulics e.g.
  - material handling
  - construction
  - agriculture
- Automotive and truck industry
- Mini hydraulics
- Lubrication
- Chemical industry
- Process industry
- Industrial gases
- Alternative fuels
- Boats and yachts
- Pneumatics
- Life Science
- Media transfer
- Sewer Cleaning
- Water jetting
- Water blasting
- Water cutting
- Hydro testing
- Bolt tensioning
- Hydraulic jacking
- Rescue equipment
- Hydraulic control
- Chemical injection
- BOP Control
- Hydraulic lines on Subsea BOPs
- Hot lines from vessel or rig to Subsea BOP
- Hydrostatic testing
- Equipment maintenance
- Well equipment testing
- Cementing operations acc. to API 7K FSL 0
- Acidizing
- General Fluid and Gas Injection
- Mud Circulation
- Jumpers
- Flying Leads
- Electro/Hydraulic Workover
- Pipeline Testing

## Value added services

Parker Polyflex and the Parker Sales Companies offer value added services that compliment our production capabilities and product portfolio. These services are in place to meet the increasing customization and system criteria that our customers expect from a world-class supplier. The value added services detailed below are typical of the products and secondary services that we provide to our customers. If you have additional service needs that we have not detailed below please contact us. We are happy to discuss all potential solutions for your requirements.

### ParkerStore™

At Parker Hannifin, we're continually looking for ways to deliver more products, more efficiently.

The Global ParkerStore™ network enables Parker to provide:

- Prompt, efficient, professional in-store services while you wait
- Expert local services and support
- A safe, friendly and convenient shopping environment
- A greater range of parts options so you get exactly what you're looking for.



Customers trust ParkerStores to provide OEM and MRO customers with direct access to:

- Custom-made hydraulic hose assemblies and complementary products to support their applications and decrease their downtime
- Expert technical support
- Professional, personalized services, including 24/7/365 support
- The convenience, comfort and amenities of a local service provider.

## The Parker® Tracking System Enterprise (PTS)



is designed to help customers reduce vehicle or asset down-time through increases in the speed, timing and accuracy of necessary repairs. PTS provides a unique 8 digit identification code and bar code printed on a durable label for each hose assembly. PTS labels are specifically engineered to withstand harsh chemicals, temperatures, UV exposure and other challenging conditions.

- PTS captures, records and recalls unique hose assembly information – on demand
- Provides fast and accurate product identification to speed up replacement regardless of where the original assembly was made.
- Assembly can be replaced with only the 8 digit PTS ID number/bar code eliminating the need to remove hoses prior to replacement. This can provide critical machine uptime and enable more conveniently scheduled repair.
- PTS includes additional reporting tools to assist in continuous improvement programmes and preventative maintenance initiatives.

## Parker HOSE DOCTORS



are a network of independently-owned, mobile service technicians built around the commitment to identify and replace hose assemblies wherever their customers need them, with the fastest response times possible. HOSE DOCTORS® are an extension of the worldwide Parker distribution network, coupling their service commitment with Parker products – the highest quality hoses and fittings available in the market today.

## Parker Store Container Service



The ParkerStore container is a transportable workshop, providing on-site maintenance and product support for large construction projects such as roadworks, tunnels, railways, underground systems, etc. Provides an on-site product and hose replacement service. With this service on your site, you can reduce your downtime keeping your project on time and on budget!

## Tech Services

Optimises the performance of your hydraulic and pneumatic circuits

- With Parker Tech Services involved, your time to market is shorter, which saves on development costs
- The 3 year no-leak guarantee enhances your reputation and lowers your warranty costs
- More reliable operation lowers your customer's operating costs
- More efficient performance and no-leak guarantee is beneficial to the environment
- Parker worldwide coverage ensures you can use the service and save costs wherever you are

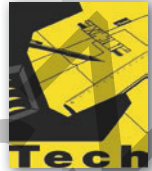

## Breadman

Lean logistics and delivery of Parker products and kits directly to the customer's assembly line, work stations or warehouse

- 100 % parts availability minimises downtime, increases production and reduces costs
- Elimination of stock checking reduces manpower and maintains production levels
- Daily delivery reduces inventory and overheads
- Electronic order processing eliminates paperwork and reduces administration costs



## Kitting

Multiple components are supplied under a single part number

- Reduced number of suppliers
- Reduced stocks and no obsolete items
- Optimized management (stock and supplies)
- Simplified and optimised order handling
- Reduced assembly costs
- Greater productivity



## Hose & Fitting Selection Database



- Always the right hose and fitting combination
- Accessories corresponding to the selected hose
- Frequent updates for new hose-fitting combinations and accessories



---

**Chapter A****General Information**

Hose selection chart by working pressure – design factor >2:1 .....	A-2
Hose selection chart by working pressure – design factor 4:1 .....	A-4
Hose fitting chart .....	A-5

KOVANZ.CZ

# Hose selection chart by working pressure – design factor >2:1

Nominal size				Working pressure MPa [psi]									
				ESH	ESH250Plus	2240D-TC	2248D-TC	2244N	2380N	2388N (size -04)	2380M	2388N (size -08)	2560N
DN	size	mm	inch										
3	-02	3.2	1/8			110 [15,950]							
4	-025	4.0	5/32			120 [17,400]	150 [21,750]						
5	-03	4.8	3/16			100 [14,500]	140 [20,300]						
6	-04	6.4	1/4			110 [15,950]			110 [15,950]	128 [18,560]	110 [15,950]		
8	-05	7.9	5/16				100 [14,500]		100 [14,500]		100 [14,500]		
10	-06	9.5	3/8					86 [12,470]					160 [23,200]
12	-08	12.7	1/2	20 [2,900]	25 [3,625]			88 [12,760]				110 [15,950]	140 [20,300]
20	-12	19.0	3/4	20 [2,900]	25 [3,625]								120 [17,400]
25	-16	25.4	1	20 [2,900]	25 [3,625]								
32	-20	31.8	1 1/4	20 [2,900]	25 [3,625]								
Fitting series				EH / NC	EH / EJ	TX / PL	TX / PL	KX / LX	BS	BS	KX	BS	BL
Page				C-2	C-5	C-8	C-9	C-16	C-19	C-20	C-25	C-27	C-30







Working pressure MPa [psi]													
2440D 2440N	2440D-TC	2448D-TC	2640D 2640N	2648N	2740D	2741D	2748D 2748D 2 <sup>nd</sup> cover	2749D	2840D	2841D	2848D	2849D	
207 [30,000]													
220 [31,900]	220 [31,900]	301 [43,640]	280 [40,600]		300 [43,500]								
180 [26,100]	180 [26,100]		250 [36,250]		280 [40,600]			301 [43,645]	400 [58,000]				
164 [23,780]	164 [23,780]		250 [36,250]										
150 [21,750]	150 [21,750]		210 [30,450]		250 [36,250]	250 [36,250]	280 [40,600]	301 [43,645]	300 [43,500]	300 [43,500]	320 [46,400]	380 [55,000]	
140 [20,300]													
130 [18,850]			180 [26,100]		200 [29,000]				250 [36,250]		300 [43,500]		
100 [14,500]			140 [20,300]	160 [23,200]									
90 [13,050]			120 [17,400]	150 [21,750]									
LX	LX	LX	JX / 2X / 5X	JX / CX	2X / HX	2X / HX	2X / HX	2X / HX	2X / WX	2X / WX	2X / WX	WX	
C-33	C-34	C-46	C-49	C-56	C-58	C-59	C-60	C-62	C-67	C-68	C-69	C-72	

# Hose selection chart by working pressure – design factor 4:1

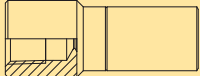
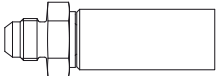

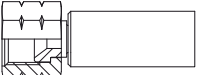

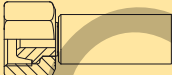
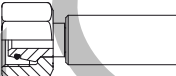

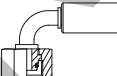
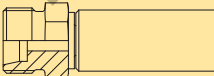



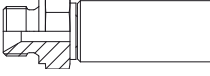

Nominal size				2022N	2244N	2380N	2380N-MSHA	2388N	2580N-MSHA
3	-02	3.2	1/8						
4	-025	4.0	5/32		75 [10,875]	75 [10,875]			
5	-03	4.8	3/16						
6	-04	6.4	1/4	69 [10,000]		70 [10,150]	70 [10,150]	80 [11,600]	
8	-05	7.9	5/16			62.5 [9,060]			
10	-06	9.5	3/8	69 [10,000]	53.5 [7,755]	57.5 [8,337]			70 [10,150]
12	-08	12.7	1/2		55 [7,975]	55 [7,975]			70 [10,150]
20	-12	19.0	3/4						
25	-16	25.4	1						
32	-20	31.8	1 1/4		27.5 [3,990]	27.5 [3,990]			
Fitting series				8X / 3X	8X / NX	8X / LX / NX	8X	8X / NX	BL
Page				B-2	B-5	B-18	B-25	B-27	B-33

**Hose fitting chart**







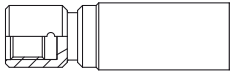

Selection

Fitting	Fitting description	Fitting designation
	National Pipe Tapered (NPT) male	01
	National Pipe Tapered (NPT) female	02
	JIC male	03
	UNF male with O-ring	05
	JIC female swivel	06
	NPSM female swivel	07
	Metric female swivel light series	C3
	Metric female swivel heavy series	C6
	Metric female swivel heavy series with O-ring	C9
	Metric female swivel heavy series with O-ring 45° elbow	0C
	Metric female swivel heavy series with O-ring 90° elbow	1C
	Metric male heavy series	D2

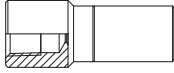
## Hose fitting chart

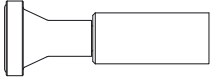
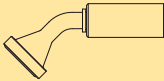
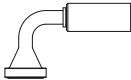
Fitting	Fitting description	Fitting designation
	BSP female swivel (60° cone)	92
	BSP female swivel (ballnose)	U0
	BSP male	D9 or 3B
	BSP male for USIT ring	Y9
	Type "M" female swivel	AY
	Medium pressure tube nipple	Y2
	Medium pressure female swivel	5Y
	High pressure female swivel	6Y
	High pressure tube nipple UNF-LH thread	Y4 or YA
	High pressure tube nipple metric-LH thread	YM
	BSP male nozzle nipple	YB
	Metric male nozzle nipple	YZ

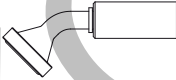
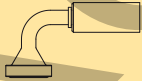
## Hose fitting chart

Fitting	Fitting description	Fitting designation
	UNF female for water jetting nozzle (left hand)	HY (-LH)
	Male water jetting nozzle	3Z or ZE
	Female water jetting nozzle	EZ
	UNF male nozzle nipple	YH
	SAE code 61 flange	15
	SAE code 61 flange 45° elbow	17
	SAE code 61 flange 90° elbow	19
	SAE code 62 flange	6A
	SAE code 62 flange 45° elbow	6F
	SAE code 62 flange 90° elbow	6N
	Metric female swivel 59° cone	MR





---

**Chapter B****Hoses with design factor 4:1****Hose**

<b>2022N</b> – High pressure hose – electrically non-conductive.....	B-2
<b>2244N</b> – High pressure hose.....	B-5
<b>2380N</b> – High pressure hose.....	B-18
<b>2380N-MSHA</b> – High pressure mining hose.....	B-25
<b>2388N</b> – High pressure hose.....	B-27
<b>2580N-MSHA</b> – High pressure mining hose.....	B-33







**2022N – High pressure hose**  
 electrically non-conductive



**CONSTRUCTION**

- Core tube** : Polyamide 11, methanol washed
- Pressure reinforcement** : Two braided layers of high tensile aramid fibre
- Cover** : Sea water resistant TPU
- Standard colour** : Orange

**TEMPERATURE RANGE** -40°C up to +55°C

#													
	DN	size	mm	inch	mm	MPa	psi	MPa	psi	mm	kg/m		
<b>2022N-04V15-10K</b>	6	-04	6.4	1/4	13.8	69.0	10,000	276	40,000	100	0.14		
<b>2022N-06V15-10K</b>	10	-06	9.7	3/8	19.0	69.0	10,000	276	40,000	100	0.24		

NOTES -

## 1068X / 1063X – JIC female swivel

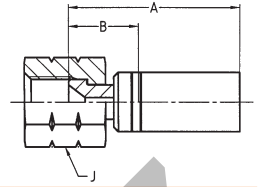

**MATERIAL** Carbon Steel, zinc plated  
C: Stainless steel (AISI 316), other materials on request.

#						A	B				Nipple ID	Ferrule OD
	DN	size	mm	inch					MPa	psi		
1068X-4-04	6	-04	6.4	1/4	7/16 - 20 UNF	57	26	19	69	10,000	2.8	18.4
1068X-5-04	6	-04	6.4	1/4	1/2 - 20 UNF	55	24	19	80	11,600	3.6	18.4
1068X-6-04C	6	-04	6.4	1/4	9/16 - 18 UNF	55	24	19	80	11,600	3.6	18.4
1063X-6-06C	10	-06	9.5	3/8	9/16 - 18 UNF	69	33	22	69.0	10,000	5.3	23.2

## 1928X / 1923X – BSP female swivel (60° cone)

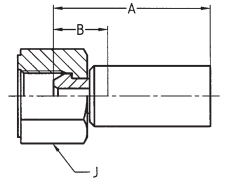

**MATERIAL** Stainless steel (AISI 316), other materials on request.

#						A	B				Nipple ID	Ferrule OD
	DN	size	mm	inch					MPa	psi		
1928X-6-04C	6	-04	6.4	1/4	G 1/4	56	25	19	69.0	10,000	3.6	18.4
1923X-8-06C	10	-06	9.5	3/8	G 1/2	66	22	30	69.0	10,000	5.3	23.2

Hoses with design factor 4:1

1C98X / 1C93X

## 1C98X / 1C93X – Metric female swivel

Heavy series

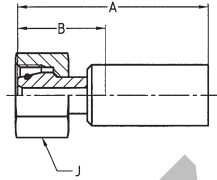

**MATERIAL** → Stainless steel (AISI 316), other materials on request.

#	⊙				⋈	A	B	J	↗		Nipple ID	Ferrule OD
	DN	size	mm	inch					MPa	psi		
1C98X-8-04C	6	-04	6.4	1/4	M16 x 1.5	59	27	19	69.0	10,000	3.6	18.4
1C98X-10-04C	6	-04	6.4	1/4	M18 x 1.5	65	33	22	69.0	10,000	3.6	18.4
1C93X-14-06C	10	-06	9.5	3/8	M22 x 1.5	75	30	30	69.0	10,000	5.3	23.2
1C93X-16-06C	10	-06	9.5	3/8	M24 x 1.5	88	34	30	69.0	10,000	5.3	23.2

## 2244N – High pressure hose









Design Factor 4:1

**CONSTRUCTION**

**Core tube** : Polyamide  
**Pressure reinforcement** : Two spiral layers, one braided layer of high tensile steel wire  
**Cover** : Polyurethane, DN32: Polyamide  
**Standard colour** : Black

**TEMPERATURE RANGE**

-40°C up to +100°C

#												
	DN	size	mm	inch	mm	MPa	psi	MPa	psi	mm	kg/m	
2244N-025V00	4	-025	3.9	5/32	9.6	75.0	10,875	300	43,500	55	0.19	
2244N-06V00	10	-06	9.8	3/8	18.0	53.5	7,755	215	31,175	120	0.50	
2244N-08V10	12	-08	12.9	1/2	22.7	55.0	7,975	220	31,900	150	0.80	
2244N-20V30	32	-20	31.8	1 1/4	44.0	27.5	3,990	110	15,950	400	1.83	

NOTES -

## 1C38X – Metric female swivel light series

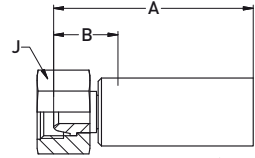

**MATERIAL** Carbon steel, zinc plated

#						A	B				Nipple ID	Ferrule OD
	DN	size	mm	inch					MPa	psi		
1C38X-8-06	10	-06	9.5	3/8	M14x1.5	61	21	19	42.0	6,090	6.8	23.8
1C38X-10-06	10	-06	9.5	3/8	M16x1.5	49	20	22	57.5	8,340	6.8	23.8
1C38X-12-06	10	-06	9.5	3/8	M18x1.5	48	19	22	57.5	8,340	6.8	23.8
1C38X-12-08	12	-08	12.7	1/2	M18x1.5	52	20	24	55.0	7,975	8.8	29.5
1C38X-15-08	12	-08	12.7	1/2	M22x1.5	51	20	27	55.0	7,975	8.8	29.5

## 1C38X – Metric female swivel light series With stainless steel nipple

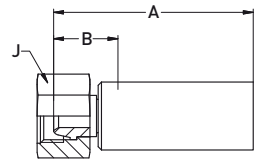

**MATERIAL** Carbon steel, zinc plated (shell and nut)  
stainless steel nipple (material 1.4301)

#						A	B				Nipple ID	Ferrule OD
	DN	size	mm	inch					MPa	psi		
1C38X-10-06C2W	10	-06	9.5	3/8	M16x1.5	49	20	22	57.5	8,340	6.8	23.8
1C38X-12-06C2W	10	-06	9.5	3/8	M18x1.5	48	19	22	57.5	8,340	6.8	23.8
1C38X-12-08C2W	12	-08	12.7	1/2	M18x1.5	52	20	24	55.0	7,975	8.8	29.5
1C38X-15-08C2W	12	-08	12.7	1/2	M22x1.5	51	20	27	55.0	7,975	8.8	29.5

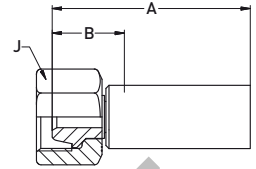
**1C68X – Metric female swivel heavy series****MATERIAL** Carbon steel, zinc plated

#						A	B				Nipple ID	Ferrule OD
	DN	size	mm	inch					MPa	psi		
1C68X-14-06	10	-06	9.5	3/8	M22x1.5	64	24	27	63.0	9,135	6.8	23.8
1C68X-16-08	12	-08	12.7	1/2	M24x1.5	67	24	30	55.0	7,975	8.8	29.5

Design Factor 4:1

**1C98X / 1C9NX – Metric female swivel heavy series with O-ring**

ISO 12151-2

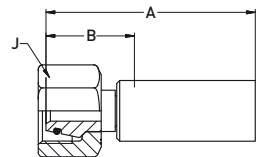
**MATERIAL** Carbon steel, zinc plated

#						A	B				Nipple ID	Ferrule OD
	DN	size	mm	inch					MPa	psi		
1C98X-8-025	4	-025	4	5/32	M16x1.5	54	27	19	75.0	10,875	2.3	13.2
1C98X-12-06	10	-06	9.5	3/8	M20x1.5	70	30	24	63.0	9,135	6.8	23.8
1C98X-14-06	10	-06	9.5	3/8	M22x1.5	71	30	27	63.0	9,135	6.8	23.8
1C98X-16-08	12	-08	12.7	1/2	M24x1.5	78	35	30	63.0	9,135	8.8	29.5
1C9NX-38-20	32	-20	31.8	1 1/4	M52x2	113	52	60	44.0	6,380	25.3	50.0

## 10C8X – Metric female swivel heavy series with O-ring, 45° elbow

ISO 12151-2

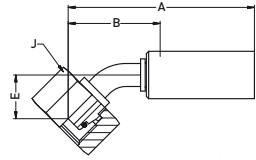

**MATERIAL** Carbon steel, zinc plated

#	⊙				⌚	A	B	E	J	↻		Nipple ID	Ferrule OD
	DN	size	mm	inch						MPa	psi		
10C8X-12-06	10	-06	9.5	3/8	M20x1.5	81	40	19	24	63.0	9,135	6.8	23.8
10C8X-14-06	10	-06	9.5	3/8	M22x1.5	81	40	19	27	63.0	9,135	6.8	23.8
10C8X-16-08	12	-08	12.7	1/2	M24x1.5	96	53	23	30	63.0	9,135	8.8	29.5

## 11C8X – Metric female swivel heavy series with O-ring, 90° elbow

ISO 12151-2

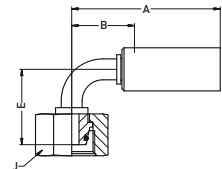

**MATERIAL** Carbon steel, zinc plated

#	⊙				⌚	A	B	E	J	↻		Nipple ID	Ferrule OD
	DN	size	mm	inch						MPa	psi		
11C8X-14-06	10	-06	9.5	3/8	M22x1.5	71	30	36	27	63.0	9,135	6.8	23.8
11C8X-16-08	12	-08	12.7	1/2	M24x1.5	85	42	44	30	63.0	9,135	8.8	29.5

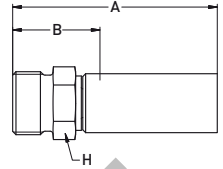

**1D28X – Metric male heavy series**  
ISO 12151-2**MATERIAL** Carbon steel, zinc plated

#	⊙				🌀	A	B	⬡	↻		Nipple ID	Ferrule OD
	DN	size	mm	inch					MPa	psi		
1D28X-12-06	10	-06	9.5	3/8	M20x1.5	69	29	22	63.0	9,135	6.8	23.8
1D28X-14-06	10	-06	9.5	3/8	M22x1.5	71	31	22	63.0	9,135	6.8	23.8
1D28X-16-08	12	-08	12.7	1/2	M24x1.5	74	31	24	63.0	9,135	8.8	29.5
1D2NX-38-20	32	-20	31.8	1 1/4	M52x1.5	106	34	55	44.0	6,380	25.3	50.0

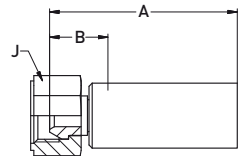
**1928X – BSP female swivel (60° cone)****MATERIAL** Carbon steel, zinc plated

#	⊙				🌀	A	B	⬡	↻		Nipple ID	Ferrule OD
	DN	size	mm	inch					MPa	psi		
1928X-4-025	4	-025	4.0	5/32	G 1/4	48	20	19	75.0	10,875	2.3	13.2
1928X-6-06	10	-06	9.5	3/8	G 3/8	59	19	22	57.5	8,340	6.8	23.8
1928X-8-06	10	-06	9.5	3/8	G 1/2	60	20	27	57.5	8,340	6.8	23.8
1928X-8-08	12	-08	12.7	1/2	G 1/2	63	20	27	55.0	7,975	8.8	29.5

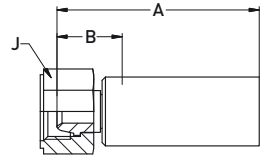
**1U08X – BSP female swivel (ballnose)****MATERIAL** Carbon steel, zinc plated

#	⊙				⋈	A	B	J	↻		Nipple ID	Ferrule OD
	DN	size	mm	inch					MPa	psi		
1U08X-6-06	10	-06	9.5	3/8	G 3/8	61	20	22	57.5	8,340	6.8	23.8
1U08X-8-06	10	-06	9.5	3/8	G 1/2	61	20	27	53.5	7,755	6.8	23.8
1U08X-8-08	12	-08	12.7	1/2	G1/2	61	22	27	55.0	7,975	6.8	23.8
1U0NX-24-20	32	-20	31.8	1 1/4	G 1 1/2	91	30	55	27.5	3,988	25.3	50.0

**1U08X – BSP female swivel (ballnose)**

With stainless steel nipple

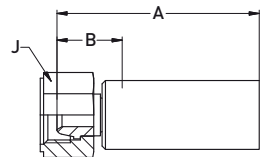
**MATERIAL** Carbon steel, zinc plated (shell and nut)  
stainless steel nipple (material 1.4301)

#	⊙				⋈	A	B	J	↻		Nipple ID	Ferrule OD
	DN	size	mm	inch					MPa	psi		
1U08X-6-06C2W	10	-06	9.5	3/8	G 3/8	61	20	22	57.5	8,340	6.8	23.8
1U08X-8-06C2W	10	-06	9.5	3/8	G 1/2	61	20	27	53.5	7,755	6.8	23.8
1U08X-8-08C2W	12	-08	12.7	1/2	G1/2	61	22	27	55.0	7,975	8.8	29.5

**13B8X / 13BNX – BSP male**

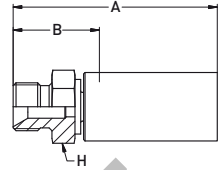

**MATERIAL** Carbon steel, zinc plated

#	⊙				⌚	A	B	⬡	↻		Nipple ID	Ferrule OD
	DN	size	mm	inch					MPa	psi		
13B8X-4-025	4	-025	4.0	5/32	G 1/4	57	30	17	75.0	10,875	2.3	13.2
13B8X-6-06	10	-06	9.5	3/8	G 3/8	71	30	22	57.5	8,340	6.8	23.8
13B8X-8-06	10	-06	9.5	3/8	G 1/2	76	35	22	57.5	8,340	6.8	23.8
13B8X-8-08	12	-08	12.7	1/2	G 1/2	79	35	24	55.0	7,974	8.8	29.5
13BNX-24-20	32	-20	31.8	1 1/4	G 1 1/2	118	57	55	44.0	6,380	25.3	50.0

**1018X – NPT male**

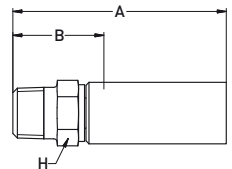

**MATERIAL** Carbon steel, zinc plated

#	⊙				⌚	A	B	⬡	↻		Nipple ID	Ferrule OD
	DN	size	mm	inch					MPa	psi		
1018X-2-025	4	-025	4.0	5/32	1/8 NPT	51	24	8	75.0	10,875	2.3	13.2
1018X-4-025	4	-025	4.0	5/32	1/4 NPT	59	32	13	75.0	10,875	2.3	13.2
1018X-6-06	10	-06	9.5	3/8	3/8 NPT	71	31	19	103.4	15,000	6.8	23.8
1018X-8-06	10	-06	9.5	3/8	1/2 NPT	76	36	22	103.4	15,000	6.8	23.8
1018X-8-08	12	-08	12.7	1/2	1/2 NPT	79	37	22	103.4	15,000	8.8	29.5

Design Factor 4:1

## 1038X / 103NX – JIC male

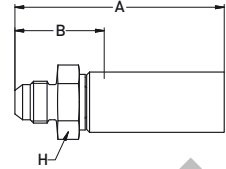

**MATERIAL** → Carbon steel, zinc plated

#	⊙				📏	A	B	⬡	↻		Nipple ID	Ferrule OD
	DN	size	mm	inch					MPa	psi		
1038X-6-06	10	-06	9.5	3/8	9/16 - 18UNF	70	30	22	53.5	7,755	6.8	23.8
1038X-8-06	10	-06	9.5	3/8	3/4 - 16UNF	74	34	22	69.0	10,000	6.8	23.8
1038X-8-08	12	-08	12.7	1/2	3/4 - 16UNF	77	35	22	69.0	10,000	8.8	29.5
1038X-10-08	12	-08	12.7	1/2	7/8 - 14UNF	83	40	24	55.0	7,974	8.8	29.5
103NX-24-20	32	-20	31.8	1 1/4	1 7/8 - 12UNF	110	49	50	44.0	6,380	25.3	50.0

## 1068X / 106NX – JIC female swivel

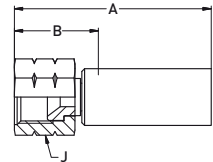

**MATERIAL** → Carbon steel, zinc plated, C: Stainless steel

#	⊙				📏	A	B	⬡	↻		Nipple ID	Ferrule OD
	DN	size	mm	inch					MPa	psi		
1068X-4-025	4	-025	4.0	5/32	7/16 - 20 UNF	55	27	14	69	10,000	2.3	13.2
1068X-6-025	4	-025	4.0	5/32	9/16 - 18 UNF	51	24	19	75	10,875	2.3	13.2
1068X-6-06	10	-06	9.5	3/8	9/16 - 18 UNF	59	18	22	69	10,000	6.8	23.8
1068X-6-06C	10	-06	9.5	3/8	9/16 - 18 UNF	59	18	22	69	10,000	6.8	23.8
1068X-8-06	10	-06	9.5	3/8	3/4 - 16 UNF	59	19	24	69	10,000	6.8	23.8
1068X-8-08	12	-08	12.7	1/2	3/4 - 16 UNF	64	21	27	69	10,000	8.8	29.5
1068X-8-08C	12	-08	12.7	1/2	3/4 - 16 UNF	64	21	27	69	10,000	8.8	29.5
1068X-10-08	12	-08	12.7	1/2	7/8 - 14 UNF	62	19	27	69	10,000	8.8	29.5
106NX-20-20	32	-20	31.8	1 1/4	1 5/8 - 12 UNF	104	44	50	44	6,380	25.3	50.0

### 1078X – NPSM female swivel

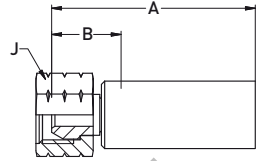

**MATERIAL** Carbon steel, zinc plated, C: Stainless steel

#	⊙				⌚	A	B	⬡	⊙		Nipple ID	Ferrule OD
	DN	size	mm	inch					MPa	psi		
1078X-6-06	10	-06	9.5	3/8	3/8 - 18NPSM	50	21	22	57.5	8,340	6.8	23.8
1078X-6-06C	10	-06	9.5	3/8	3/8 - 18NPSM	50	21	22	57.5	8,340	6.8	23.8
1078X-8-08	12	-08	12.7	1/2	1/2 - 14NPSM	50	19	27	55.0	7,975	8.8	29.5
1078X-8-08C	12	-08	12.7	1/2	1/2 - 14NPSM	50	19	27	55.0	7,975	8.8	29.5

Design Factor 4:1

### 1078X – NPSM female swivel With stainless steel nipple

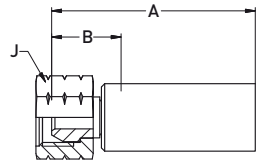

**MATERIAL** Carbon steel, zinc plated  
stainless steel nipple (material 1.4301)

#	⊙				⌚	A	B	⬡	⊙		Nipple ID	Ferrule OD
	DN	size	mm	inch					MPa	psi		
1078X-6-06C2W	10	-06	9.5	3/8	3/8 - 18NPSM	50	21	22	57.5	8,340	6.8	23.8
1078X-8-08C2W	12	-08	12.7	1/2	1/2 - 14NPSM	50	19	27	55.0	7,975	8.8	29.5

Hoses with design factor 4:1

1A Y8X – 1158X / 115NX

## 1A Y8X – Type “M” female swivel

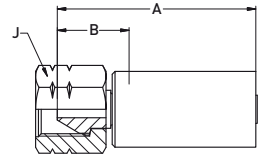

**MATERIAL** Carbon steel, zinc plated

#	⊙				⋈	A	B	J	↗		Nipple ID	Ferrule OD
	DN	size	mm	inch					MPa	psi		
1A Y8X-6-025	4	-025	4.0	5/32	9/16 - 18 UNF	56	28	19	75	10,875	2.3	13.2

## 1158X / 115NX – SAE code 61 flange ISO 12151-3

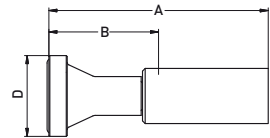

**MATERIAL** Carbon steel, zinc plated

#	⊙				A	B	D	↗		Nipple ID	Ferrule OD
	DN	size	mm	inch				MPa	psi		
1158X-8-08	12	-08	12.7	1/2	87	44	30	21	3,000	8.8	29.5
115NX-20-20	32	-20	31.8	1 1/4	117	56	51	21	3,000	25.3	50.0

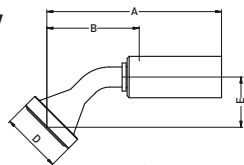
**1178X / 117NX – SAE code 61 flange 45° elbow**  
ISO 12151-3**MATERIAL** Carbon steel, zinc plated

#	⊙				A	B	D	E	↻		Nipple ID	Ferrule OD
	DN	size	mm	inch					MPa	psi		
1178X-8-08	12	-08	12.7	1/2	95	53	30	20	55.0	7,974	8.8	29.5
117NX-20-20	32	-20	31.8	1 1/4	174	113	51	37	44.0	6,380	25.3	50.0

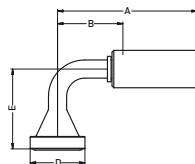
**1198X / 119NX – SAE code 61 flange 90° elbow**  
ISO 12151-3**MATERIAL** Carbon steel, zinc plated

#	⊙				A	B	D	E	↻		Nipple ID	Ferrule OD
	DN	size	mm	inch					MPa	psi		
1198X-8-08	12	-08	12.7	1/2	78	35	30	44	55.0	7,974	8.8	29.5
119NX-20-20	32	-20	31.8	1 1/4	165	104	51	82	44.0	6,380	25.3	50.0

Hoses with design factor 4:1  
**16A8X / 16ANX – 16F8X / 16FNX**

**16A8X / 16ANX – SAE code 62 flange**  
 ISO 12151-3

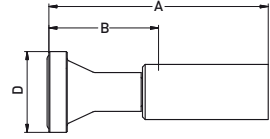

**MATERIAL** Carbon steel, zinc plated

#	⊙				A	B	D	↻		Nipple ID	Ferrule OD
	DN	size	mm	inch				MPa	psi		
16A8X-8-08	12	-08	12.7	1/2	88	45	32	55.0	7,974	8.8	29.5
16ANX-20-20	32	-20	31.8	1 1/4	126	65	54	44.0	6,380	25.3	50.0

**16F8X / 16FNX – SAE code 62 flange**  
**45° elbow**

ISO 12151-3

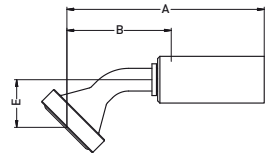

**MATERIAL** Carbon steel, zinc plated

#	⊙				A	B	D	E	↻		Nipple ID	Ferrule OD
	DN	size	mm	inch					MPa	psi		
16F8X-8-08	12	-08	12.7	1/2	95	52	32	21	55.0	7,974	8.8	29.5
16FNX-20-20	32	-20	31.8	1 1/4	180	119	54	44	44.0	6,380	25.3	50.0



**16N8X / 16NNX – SAE code 62 flange  
90° elbow**

ISO 12151-3

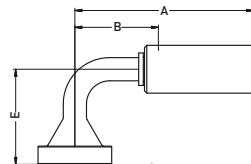
**MATERIAL** Carbon steel, zinc plated

#	⊙				A	B	D	E	↗		Nipple ID	Ferrule OD
	DN	size	mm	inch					mm	mm		
16N8X-8-08	12	-08	12.7	1/2	87	44	32	41	55.0	7,974	8.8	29.5
16NNX-20-20	32	-20	31.8	1 1/4	165	104	54	91	44.0	6,380	25.3	50.0

## 2380N – High pressure hose



**CONSTRUCTION**

- Core tube** : Polyamide
- Pressure reinforcement** : Two spiral layers and two open spiral layers of high tensile steel wire
- Cover** : Polyurethane, DN32: Polyamide
- Standard colour** : Black

**TEMPERATURE RANGE** -40°C up to +100°C

#	Ø				Ø		↗		↘		kg/m
	DN	size	mm	inch	mm	MPa	psi	MPa	psi	mm	
2380N-025V10	4	-025	3.9	5/32	9.7	75.0	10,875	300	43,500	55	0.16
2380N-04V00	6	-04	6.3	1/4	13.3	70.0	10,150	280	40,600	70	0.27
2380N-05V00	8	-05	8.3	5/16	15.8	62.5	9,060	250	36,250	90	0.35
2380N-06V10	10	-06	9.8	3/8	17.9	57.5	8,337	230	33,350	120	0.44
2380N-08V10	12	-08	12.9	1/2	22.9	55.0	7,975	220	31,900	150	0.68
2380N-20V30	32	-20	31.8	1 1/4	44.0	27.5	3,985	110	15,950	400	1.83

NOTES -

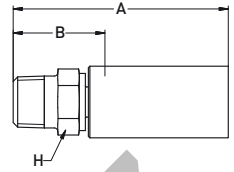
**1018X – National Pipe Tapered (NPT)  
male****MATERIAL** Carbon steel, zinc plated, C: Stainless steel

#	⊙				⌚	A	B	⬡	⊙		Nipple ID	Ferrule OD
	DN	size	mm	inch					MPa	psi		
1018X-2-025	4	-025	4.0	5/32	1/8 NPT	51	24	8	75.0	10,875	2.3	13.2
1018X-4-025	4	-025	4.0	5/32	1/4 NPT	59	32	13	75.0	10,875	2.3	13.2
1018X-1-04	6	-04	6.4	1/4	1/16 NPT	59	27	14	103.4	15,000	3.6	18.5
1018X-2-04	6	-04	6.4	1/4	1/8 NPT	60	28	13	103.4	15,000	3.6	18.5
1018X-4-04	6	-04	6.4	1/4	1/4 NPT	65	33	14	103.4	15,000	3.6	18.5
1018X-4-04C	6	-04	6.4	1/4	1/4 NPT	65	33	14	103.4	15,000	3.6	18.5
1018X-6-04	6	-04	6.4	1/4	3/8 NPT	67	35	19	103.4	15,000	3.6	18.5
1018X-6-04C	6	-04	6.4	1/4	3/8 NPT	67	35	19	103.4	15,000	3.6	18.5
1018X-4-05	8	-05	7.9	5/16	1/4 NPT	61	30	14	103.4	15,000	4.8	20.1
1018X-4-05C	8	-05	7.9	5/16	1/4 NPT	61	30	14	103.4	15,000	4.8	20.1
1018X-6-05	8	-05	7.9	5/16	3/8 NPT	70	30	19	103.4	15,000	4.8	20.1
1018X-6-05C	8	-05	7.9	5/16	3/8 NPT	70	30	19	103.4	15,000	4.8	20.1
1018X-6-06	10	-06	9.5	3/8	3/8 NPT	71	31	19	103.4	15,000	6.8	23.4
1018X-6-06C	10	-06	9.5	3/8	3/8 NPT	71	31	19	103.4	15,000	6.8	23.4
1018X-8-06	10	-06	9.5	3/8	1/2 NPT	76	36	22	103.4	15,000	6.8	23.4
1018X-8-06C	10	-06	9.5	3/8	1/2 NPT	76	36	22	103.4	15,000	6.8	23.4
1018X-8-08	12	-08	12.7	1/2	1/2 NPT	79	37	22	103.4	15,000	6.6	30.0
1018X-8-08C	12	-08	12.7	1/2	1/2 NPT	79	37	22	103.4	15,000	6.6	30.0

## 1058X – UNF male with O-ring

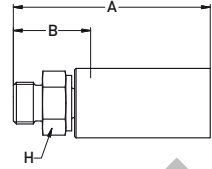

**MATERIAL** → Special materials

#	⊙				📏	A	B	⬡	↻		Nipple ID	Ferrule OD
	DN	size	mm	inch					MPa	psi		
1058X-4-04	6	-04	6.4	1/4	7/16 - 20 UNF	61	29	14	80	11,600	3.6	18.5
1058X-6-04	6	-04	6.4	1/4	9/16 - 18 UNF	62	30	17	80	11,600	3.6	18.5

## 1068X – JIC female swivel

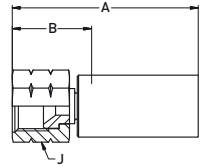

**MATERIAL** → Carbon steel, zinc plated, C: Stainless steel

#	⊙				📏	A	B	⬡	↻		Nipple ID	Ferrule OD
	DN	size	mm	inch					MPa	psi		
1068X-4-04	6	-04	6.4	1/4	7/16 - 20 UNF	57	26	19	69.0	10,000	2.8	18.5
1068X-4-04C	6	-04	6.4	1/4	7/16 - 20 UNF	57	26	19	69.0	10,000	2.8	18.5
1068X-5-04	6	-04	6.4	1/4	1/2 - 20 UNF	55	24	19	80.0	11,600	2.8	18.5
1068X-5-04C	6	-04	6.4	1/4	1/2 - 20 UNF	55	24	19	80.0	11,600	2.8	18.5
1068X-6-04	6	-04	6.4	1/4	9/16 - 18 UNF	55	24	19	80.0	11,600	3.6	18.5
1068X-6-04C	6	-04	6.4	1/4	9/16 - 18 UNF	55	24	19	80.0	11,600	3.6	18.5
1068X-6-05	8	-05	7.9	5/16	9/16 - 18 UNF	56	16	19	69.0	10,000	4.8	20.1
1068X-6-05C	8	-05	7.9	5/16	9/16 - 18 UNF	56	16	19	69.0	10,000	4.8	20.1
1068X-8-05	8	-05	7.9	5/16	3/4 - 16 UNF	64	33	24	69.0	10,000	4.8	20.1
1068X-6-06	10	-06	9.5	3/8	9/16 - 18 UNF	59	18	22	69.0	10,000	4.8	23.4
1068X-6-06C	10	-06	9.5	3/8	9/16 - 18 UNF	59	18	22	69.0	10,000	4.8	23.4
1068X-8-08	12	-08	12.7	1/2	3/4 - 16 UNF	64	21	27	69.0	10,000	6.6	30.0
1068X-8-08C	12	-08	12.7	1/2	3/4 - 16 UNF	64	21	27	69.0	10,000	6.6	30.0

## 1928X / 192LX – BSP female swivel (60° cone)

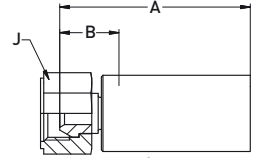

**MATERIAL** Carbon steel, zinc plated, C: Stainless steel

#	⊙				⌚	A	B	⬡	↻		Nipple ID	Ferrule OD
	DN	size	mm	inch					MPa	psi		
1928X-4-025	4	-025	4.0	5/32	G 1/4	48	20	19	75.0	10,875	2.3	13.2
1928X-4-04	6	-04	6.4	1/4	G 1/4	56	25	19	80.0	11,600	3.6	18.5
1928X-4-04C	6	-04	6.4	1/4	G 1/4	56	25	19	80.0	11,600	3.6	18.5
1928X-6-06	10	-06	9.5	3/8	G 3/8	59	19	22	57.5	8,340	6.8	23.4
1928X-6-06C	10	-06	9.5	3/8	G 3/8	59	19	22	57.5	8,340	6.8	23.4
1928X-8-06	10	-06	9.5	3/8	G 1/2	60	20	27	57.5	8,340	6.8	23.4
1928X-8-06C	10	-06	9.5	3/8	G 1/2	60	20	27	57.5	8,340	6.8	23.4
192LX-8-08	12	-08	12.7	1/2	G 1/2	75	21	30	130.0	18,850	6.7	30.7
192LX-8-08C	12	-08	12.7	1/2	G 1/2	75	21	30	130.0	18,850	6.7	30.7

## 1D98X – BSP male

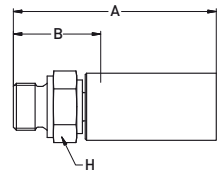

**MATERIAL** Carbon steel, zinc plated, C: Stainless steel

#	⊙				⌚	A	B	⬡	↻		Nipple ID	Ferrule OD
	DN	size	mm	inch					MPa	psi		
1D98X-4-025	4	-025	4.0	5/32	G 1/4	60	33	19	75.0	10,875	2.3	13.2
1D98X-4-025C	4	-025	4.0	5/32	G 1/4	60	33	19	75.0	10,875	2.3	13.2
1D98X-4-04	6	-04	6.4	1/4	G 1/4	67	35	19	80.0	11,600	3.6	18.5
1D98X-4-04C	6	-04	6.4	1/4	G 1/4	67	35	19	80.0	11,600	3.6	18.5
1D98X-6-04	6	-04	6.4	1/4	G 3/8	69	37	22	80.0	11,600	3.6	18.5
1D98X-6-04C	6	-04	6.4	1/4	G 3/8	69	37	22	80.0	11,600	3.6	18.5
1D98X-6-05	8	-05	7.9	5/16	G 3/8	70	31	22	62.5	9,060	4.8	20.1
1D98X-6-06	10	-06	9.5	3/8	G 3/8	70	30	22	57.5	8,340	6.8	23.4
1D98X-6-06C	10	-06	9.5	3/8	G 3/8	70	30	22	57.5	8,340	6.8	23.4
1D98X-8-08	12	-08	12.7	1/2	G 1/2	77	35	27	55.0	7,974	6.6	30.0

## 1AY8X – Type “M” female swivel

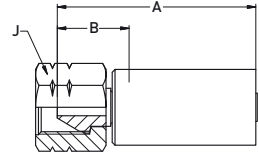

**MATERIAL** Carbon steel, zinc plated

#	⊙				⋈	A	B	J	↻		Nipple ID	Ferrule OD
	DN	size	mm	inch					MPa	psi		
1AY8X-6-04	6	-04	6.4	1/4	9/16 - 18 UNF	60	28	19	80.0	11,600	3.6	18.5
1AY8X-8-05	8	-05	7.9	5/16	3/4 - 16 UNF	74	30	27	69.0	10,000	4.8	20.1
1AY8X-8-06	10	-06	9.5	3/8	3/4 - 16 UNF	70	26	27	57.5	8,340	6.8	23.4

## 1078X – NPSM female swivel

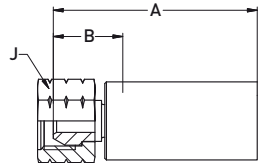

**MATERIAL** Carbon steel, zinc plated

**NOTE** C2W: Stainless steel nipple

#	⊙				⋈	A	B	J	↻		Nipple ID	Ferrule OD
	DN	size	mm	inch					MPa	psi		
1078X-4-04	6	-04	6.4	1/4	1/4 - 18NPSM	59	28	19	80.0	11,600	3.6	18.5
1078X-4-04C2W	6	-04	6.4	1/4	1/4 - 18NPSM	59	28	19	80.0	11,600	3.6	18.5
1078X-6-05	8	-05	7.9	5/16	3/8 - 18NPSM	60	21	22	62.5	9,060	4.8	20.1
1078X-6-05C2W	8	-05	7.9	5/16	3/8 - 18NPSM	60	21	22	62.5	9,060	4.8	20.1
1078X-6-06	10	-06	9.5	3/8	3/8 - 18NPSM	62	21	22	57.5	8,340	6.8	23.4
1078X-6-06C2W	10	-06	9.5	3/8	3/8 - 18NPSM	62	21	22	57.5	8,340	6.8	23.4

## 1U08X – BSP female swivel (ballnose)

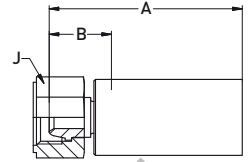
**MATERIAL** Carbon steel, zinc plated**NOTE** C2W: Stainless steel nipple

#	⊙				⋄	A	B	⬡	↻		Nipple ID	Ferrule OD
	DN	size	mm	inch					MPa	psi		
1U08X-4-04	6	-04	6.4	1/4	G 1/4	58	27	19	80.0	11,600	3.6	18.5
1U08X-4-04C2W	6	-04	6.4	1/4	G 1/4	58	27	19	80.0	11,600	3.6	18.5
1U08X-6-04	6	-04	6.4	1/4	G 3/8	58	27	27	80.0	11,600	3.6	18.5
1U08X-6-04C2W	6	-04	6.4	1/4	G 3/8	58	27	27	80.0	11,600	3.6	18.5
1U08X-6-05	8	-05	7.9	5/16	G 3/8	59	19	19	62.5	9,060	4.8	20.1
1U08X-6-05C2W	8	-05	7.9	5/16	G 3/8	59	19	19	62.5	9,060	4.8	20.1
1U08X-6-06	10	-06	9.5	3/8	G 3/8	61	20	22	57.5	8,340	6.8	23.4
1U08X-6-06C2W	10	-06	9.5	3/8	G 3/8	61	20	22	57.5	8,340	6.8	23.4
1U08X-8-06	10	-06	9.5	3/8	G 1/2	61	20	27	57.5	8,340	6.8	23.4
1U08X-8-06C2W	10	-06	9.5	3/8	G 1/2	61	20	27	57.5	8,340	6.8	23.4
1U08X-8-08	12	-08	12.7	1/2	G 1/2	61	22	27	55.0	7,975	6.6	30.0

## 13B8X / 13BNX – BSP male

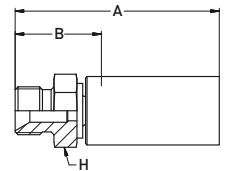
**MATERIAL** Carbon steel, zinc plated

#	⊙				⋄	A	B	⬡	↻		Nipple ID	Ferrule OD
	DN	size	mm	inch					MPa	psi		
13B8X-4-025	4	-025	4.0	5/32	G 1/4	57	30	17	75.0	10,875	2.3	13.2
13B8X-4-04	6	-04	6.4	1/4	G 1/4	64	32	17	80.0	11,600	3.6	18.5
13B8X-6-04	6	-04	6.4	1/4	G 3/8	67	35	19	80.0	11,600	3.6	18.5
13B8X-6-05	8	-05	7.9	5/16	G 3/8	69	30	22	62.5	9,060	4.8	20.1
13B8X-6-06	10	-06	9.5	3/8	G 3/8	70	30	22	57.5	8,340	6.8	23.4
13B8X-8-06	10	-06	9.5	3/8	G 1/2	75	35	22	57.5	8,340	6.8	23.4
13B8X-8-08	12	-08	12.7	1/2	G 1/2	79	35	24	55.0	7,974	6.6	30.0
13BNX-24-20	32	-20	31.8	1 1/4	G 1 1/2	118	57	55	27.5	3,990	24.9	49.4

# 1C98X / 1C9LX / 1C9NX – Metric female swivel heavy series with O-ring

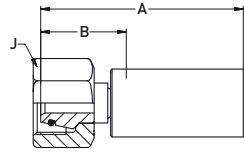

**MATERIAL** Carbon steel, zinc plated, C: Stainless steel

#	⊙				⌚	A	B	J	↗		Nipple ID	Ferrule OD
	DN	size	mm	inch					MPa	psi		
1C98X-8-025	4	-025	4.0	5/32	M16x1.5	54	27	19	75.0	10,875	2.3	13.2
1C98X-8-025C	4	-025	4.0	5/32	M16x1.5	54	27	19	75.0	10,875	2.3	13.2
1C98X-8-04	6	-04	6.4	1/4	M16x1.5	59	27	19	80.0	11,600	3.6	18.5
1C98X-8-04C	6	-04	6.4	1/4	M16x1.5	59	27	19	80.0	11,600	3.6	18.5
1C98X-10-04	6	-04	6.4	1/4	M18x1.5	56	33	22	80.0	11,600	3.6	18.5
1C98X-10-04C	6	-04	6.4	1/4	M18x1.5	56	33	22	80.0	11,600	3.6	18.5
1C98X-12-04	6	-04	6.4	1/4	M20x1.5	69	37	24	80.0	11,600	3.6	18.5
1C98X-12-05	8	-05	7.9	5/16	M20x1.5	62	23	24	63.0	9,135	4.8	20.1
1C98X-16-05	8	-05	7.9	5/16	M24x1.5	65	25	30	63.0	9,135	4.8	20.1
1C98X-12-06	10	-06	9.5	3/8	M20x1.5	70	30	24	63.0	9,135	6.8	23.4
1C98X-12-06C	10	-06	9.5	3/8	M20x1.5	70	30	24	63.0	9,135	6.8	23.4
1C98X-14-06	10	-06	9.5	3/8	M22x1.5	70	30	27	63.0	9,135	6.8	23.4
1C98X-14-06C	10	-06	9.5	3/8	M22x1.5	70	30	27	63.0	9,135	6.8	23.4
1C9LX-16-08	12	-08	12.7	1/2	M24x1.5	88	34	30	130.0	18,850	6.6	30.0
1C9NX-38-20	32	-20	31.8	1 1/4	M52x2	113	52	60	44.0	6,380	24.9	49.4



## 2380N-MSHA – High pressure mining hose



Design Factor 4:1







## CONSTRUCTION

Core tube : Polyamide  
 Pressure reinforcement : Two spiral layers and two open spiral layers of high tensile steel wire  
 Cover : Polyurethane, MSHA approved  
 Standard colour : Black

## TEMPERATURE RANGE

-40°C up to +100°C

## Mining applications

#													
	DN	size	mm	inch	mm	MPa	psi	MPa	psi	mm	kg/m		
2380N-04V10-MSHA	6	-04	6.3	1/4	13.3	70	10,150	280	40,600	70	0.28		

NOTES -

## 1018X – National Pipe Tapered (NPT) male

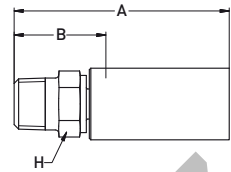

**MATERIAL** Carbon steel, zinc plated; ZE: Carbon steel, special plating for high corrosion protection in mining applications







#	⊙				⌚	A	B	⬡	↗		Nipple ID	Ferrule OD
	DN	size	mm	inch					MPa	psi		
1018X-4-04ZE	6	-04	6.4	1/4	1/4 NPT	65	33	14	103.4	15,000	3.6	18.5
1018X-6-04ZE	6	-04	6.4	1/4	3/8 NPT	67	35	19	103.4	15,000	3.6	18.5

**2388N – High pressure hose**

**CONSTRUCTION**

- Core tube** : Polyamide
- Pressure reinforcement** : Two spiral layers and two open spiral layers of high tensile steel wire
- Cover** : Polyurethane
- Standard colour** : Black

**TEMPERATURE RANGE** -40°C up to +100°C

#													
	DN	size	mm	inch	mm	MPa	psi	MPa	psi	mm	kg/m		
2388N-04V00	6	-04	6.3	1/4	13.3	80	11,600	320	46,400	80	0.30		

NOTES -

## 1018X – National Pipe Tapered (NPT) male

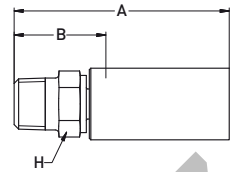

**MATERIAL** → Carbon steel, zinc plated, C: Stainless steel

#	⊙				⋯	A	B	⬡	⊙		Nipple ID	Ferrule OD
	DN	size	mm	inch					MPa	psi		
1018X-1-04	6	-04	6.4	1/4	1/16 NPT	59	27	14	103.4	15,000	3.6	18.3
1018X-2-04	6	-04	6.4	1/4	1/8 NPT	60	28	13	103.4	15,000	3.6	18.3
1018X-4-04	6	-04	6.4	1/4	1/4 NPT	65	33	14	103.4	15,000	3.6	18.3
1018X-4-04C	6	-04	6.4	1/4	1/4 NPT	65	33	14	103.4	15,000	3.6	18.3
1018X-6-04	6	-04	6.4	1/4	3/8 NPT	67	35	19	103.4	15,000	3.6	18.3
1018X-6-04C	6	-04	6.4	1/4	3/8 NPT	67	35	19	103.4	15,000	3.6	18.3

## 1058X – UNF male with O-ring

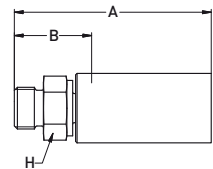

**MATERIAL** → Special materials

#	⊙				⋯	A	B	⬡	⊙		Nipple ID	Ferrule OD
	DN	size	mm	inch					MPa	psi		
1058X-4-04	6	-04	6.4	1/4	7/16 - 20 UNF	61	29	14	80	11,600	3.6	18.3
1058X-6-04	6	-04	6.4	1/4	9/16 - 18 UNF	62	30	17	80	11,600	3.6	18.3

## 1068X – JIC female swivel

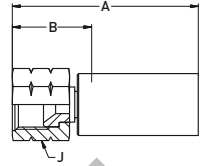

**MATERIAL** Carbon steel, zinc plated, C: Stainless steel

#	⊙				⋈	A	B	J	⊙		Nipple ID	Ferrule OD
	DN	size	mm	inch					MPa	psi		
1068X-4-04	6	-04	6.4	1/4	7/16 - 20 UNF	57	26	19	69.0	10,000	2.8	18.3
1068X-4-04C	6	-04	6.4	1/4	7/16 - 20 UNF	57	26	19	69.0	10,000	2.8	18.3
1068X-5-04	6	-04	6.4	1/4	1/2 - 20 UNF	55	24	19	80.0	11,600	3.6	18.3
1068X-5-04C	6	-04	6.4	1/4	1/2 - 20 UNF	55	24	19	80.0	11,600	3.6	18.3
1068X-6-04	6	-04	6.4	1/4	9/16 - 18 UNF	55	24	19	80.0	11,600	3.6	18.3
1068X-6-04C	6	-04	6.4	1/4	9/16 - 18 UNF	55	24	19	80.0	11,600	3.6	18.3

## 1928X – BSP female swivel (60° cone)

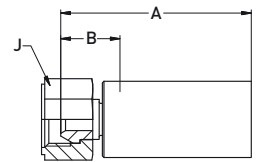



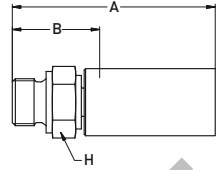

**MATERIAL** Carbon steel, zinc plated, C: Stainless steel

#	⊙				⋈	A	B	J	⊙		Nipple ID	Ferrule OD
	DN	size	mm	inch					MPa	psi		
1928X-4-04	6	-04	6.4	1/4	G 1/4	56	25	19	80.0	11,600	3.6	18.3
1928X-4-04C	6	-04	6.4	1/4	G 1/4	56	25	19	80.0	11,600	3.6	18.3

## 1D98X – BSP male





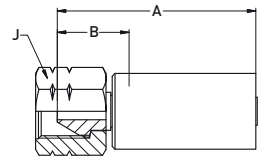

**MATERIAL** → Carbon steel, zinc plated, C: Stainless steel

#						A	B			Nipple ID	Ferrule OD	
	DN	size	mm	inch								mm
<b>1D98X-4-04</b>	6	-04	6.4	1/4	G 1/4	67	35	19	80.0	11,600	3.6	18.3
<b>1D98X-4-04C</b>	6	-04	6.4	1/4	G 1/4	67	35	19	80.0	11,600	3.6	18.3

## 1A98X – Type “M” female swivel



**MATERIAL** → Carbon steel, zinc plated

#						A	B			Nipple ID	Ferrule OD	
	DN	size	mm	inch								mm
<b>1A98X-6-04</b>	6	-04	6.4	1/4	9/16 - 18 UNF	60	28	19	80.0	11,600	3.6	18.3

## 1078X – NPSM female swivel

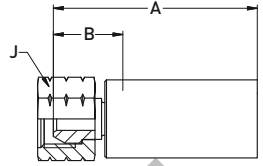
**MATERIAL** Carbon steel, zinc plated**NOTE** C2W: Stainless steel nipple

#	⊙				⋄	A	B	J	↻		Nipple ID	Ferrule OD
	DN	size	mm	inch					MPa	psi		
1078X-4-04	6	-04	6.4	1/4	1/4 - 18NPSM	59	28	19	80.0	11,600	3.6	18.3
1078X-4-04C2W	6	-04	6.4	1/4	1/4 - 18NPSM	59	28	19	80	11,600	3.6	18.3

## 1U08X – BSP female swivel (ballnose)

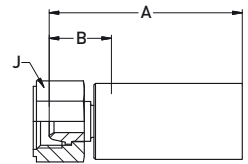
**MATERIAL** Carbon steel, zinc plated**NOTE** C2W: Stainless steel nipple

#	⊙				⋄	A	B	J	↻		Nipple ID	Ferrule OD
	DN	size	mm	inch					MPa	psi		
1U08X-4-04	6	-04	6.4	1/4	G 1/4	58	27	19	80.0	11,600	3.6	18.3
1U08X-4-04C2W	6	-04	6.4	1/4	G 1/4	58	27	19	80	11,600	3.6	18.3
1U08X-6-04	6	-04	6.4	1/4	G 3/8	58	27	27	80.0	11,600	3.6	18.3
1U08X-6-04C2W	6	-04	6.4	1/4	G 3/8	58	27	27	80	11,600	3.6	18.3

## 13B8X – BSP male

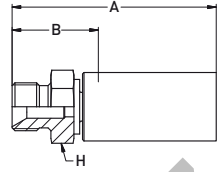

**MATERIAL** Carbon steel, zinc plated

#	⊙				⌚	A	B	⬡	⊙		Nipple ID	Ferrule OD
	DN	size	mm	inch					MPa	psi		
13B8X-4-04	6	-04	6.4	1/4	G 1/4	64	32	17	80.0	11,600	3.6	18.3
13B8X-6-04	6	-04	6.4	1/4	G 3/8	67	35	19	80.0	11,600	3.6	18.3

## 1C98X / 1C9NX – Metric female swivel heavy series with O-ring

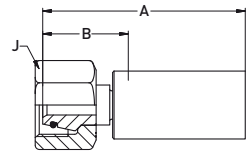

**MATERIAL** Carbon steel, zinc plated, C: Stainless steel

#	⊙				⌚	A	B	⬡	⊙		Nipple ID	Ferrule OD
	DN	size	mm	inch					MPa	psi		
1C98X-8-04	6	-04	6.4	1/4	M16x1.5	59	27	19	80.0	11,600	3.6	18.3
1C98X-8-04C	6	-04	6.4	1/4	M16x1.5	59	27	19	80.0	11,600	3.6	18.3
1C98X-10-04	6	-04	6.4	1/4	M18x1.5	56	33	22	80.0	11,600	3.6	18.3
1C98X-10-04C	6	-04	6.4	1/4	M18x1.5	56	33	22	80.0	11,600	3.6	18.3
1C98X-12-04	6	-04	6.4	1/4	M20x1.5	69	37	24	80.0	11,600	3.6	18.3

Design Factor 4:1



## 2580N-MSHA – High pressure mining hose



<b>CONSTRUCTION</b>	<b>Core tube</b>	: Polyamide
	<b>Pressure reinforcement</b>	: Four spiral layers and two open spiral layers of high tensile steel wire
	<b>Cover</b>	: Polyurethane, MSHA approved
	<b>Standard colour</b>	: Black

**TEMPERATURE RANGE** -40°C up to +100°C

## Mining applications

#													
	DN	size	mm	inch	mm	MPa	psi	MPa	psi	mm	kg/m		
2580N-06V10-MSHA	10	-06	9.8	3/8	21.6	70	10,150	280	40,600	95	0.94		
2580N-08V10-MSHA	12	-08	12.9	1/2	25.0	70	10,150	280	40,600	110	1.19		

NOTES -

Hoses with design factor 4:1

101BL

## 101BL – National Pipe Tapered (NPT) male

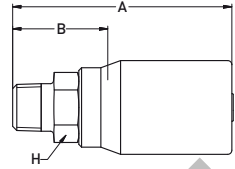

**MATERIAL** Carbon steel, zinc plated; ZE: Carbon steel, special plating for high corrosion protection in mining applications

#	⊙				⌚	A	B	⬡	↗		Nipple ID	Ferrule OD
	DN	size	mm	inch					MPa	psi		
101BL-6-06ZE	10	-06	9.5	3/8	3/8 NPT	80	35	22	160	23,200	5.5	28.5
101BL-8-08ZE	12	-08	12.7	1/2	1/2 NPT	90	45	22	140	20,300	6.9	30.0

## Chapter C

### Hoses with design factor >2:1

#### Hose

<b>ESH</b>	– Sewer cleaning hose.....	C-2
<b>ESH250<sup>plus</sup></b>	– Sewer cleaning hose.....	C-5
<b>2240D</b>	– TOUGH COVER High pressure hose.....	C-8
<b>2248D</b>	– TOUGH COVER High pressure hose.....	C-9
<b>2244N</b>	– High pressure hose.....	C-16
<b>2380N</b>	– High pressure hose.....	C-19
<b>2388N</b>	– High pressure hose (size -04).....	C-20
<b>2380M</b>	– High pressure hose.....	C-25
<b>2388N</b>	– High pressure hose (size -08).....	C-27
<b>2580N</b>	– High pressure hose.....	C-30
<b>2440D</b>	– Ultra-high pressure hose.....	C-33
<b>2440N</b>	– Ultra-high pressure hose.....	C-33
<b>2440D</b>	– TOUGH COVER Ultra-high pressure hose.....	C-34
<b>2448D</b>	– TOUGH COVER Ultra-high pressure hose.....	C-46
<b>2640D</b>	– Ultra-high pressure hose.....	C-49
<b>2640N</b>	– Ultra-high pressure hose.....	C-49
<b>2648N</b>	– Ultra-high pressure hose.....	C-56
<b>2740D</b>	– Ultra-high pressure hose.....	C-58
<b>2741D</b>	– Ultra-high pressure hose with 2nd cover.....	C-59
<b>2748D</b>	– Ultra-high pressure hose.....	C-60
<b>2748D</b>	– Ultra-high pressure hose with 2nd cover.....	C-61
<b>2749D</b>	– Ultra-high pressure hose.....	C-62
<b>2840D</b>	– Ultra-high pressure hose.....	C-67
<b>2841D</b>	– Ultra-high pressure hose.....	C-68
<b>2848D</b>	– Ultra-high pressure hose.....	C-69
<b>2849D</b>	– Ultra-high pressure hose.....	C-72

## ESH – Sewer cleaning hose



<b>CONSTRUCTION</b>	<b>Core tube</b>	: Polyethylene compound, grey
	<b>Pressure reinforcement</b>	: Two braided layers of high tensile synthetic yarn
	<b>Cover</b>	: Polyurethane compound
	<b>Standard colour</b>	: Yellow

**TEMPERATURE RANGE** -10°C up to +50°C

#	Ø				Ø		Ø		Ø		mm	kg/m
	DN	size	mm	inch	mm	MPa	psi	MPa	psi			
ESH-08	12	-08	12.7	1/2	20.6	20	2,900	50	7250	100	0.23	
ESH-12	20	-12	19.2	3/4	28.6	20	2,900	50	7250	125	0.37	
ESH-16	25	-16	25.3	1	36.6	20	2,900	50	7250	150	0.59	
ESH-20	32	-20	31.9	1 1/4	46.0	20	2,900	50	7250	225	0.89	

### Hose assemblies

#	Length (m)						Fittings	
	Standard					max.	BSP female swivel	BSP male
	80	100	120	160	180			
ESH-08	•	•	•	•	•	500	G 1/2	G 1/2
ESH-12	•	•	•	•	•	500	G 3/4	G 3/4
ESH-16	•	•	•	•	•	500	G 1	G 1
ESH-20	•	•	•	•	•	400	G 1 1/4	G 1 1/4

### NOTES

- ESH available as bulk hose on a drum
- Crimp on a Parkrimp system or on a free adjustable crimper

### 192EH – BSP female swivel (60° cone)

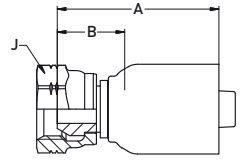

**MATERIAL** Carbon steel zinc plated

#	⊙				⌚	A	B	J	↗	
	DN	size	mm	inch					MPa	psi
192EH-08-08	12	-08	12.8	1/2	G 1/2	57	22	27	25	3,625
192EH-12-12	20	-12	19.6	3/4	G 3/4	61	22	32	25	3,625
192EH-16-16	25	-16	25.0	1	G 1	55	25	41	25	3,625
192EH-20-20	32	-20	32.0	1 1/4	G 1 1/4	80	32	50	25	3,625

### 1D9EH – BSP male

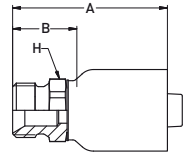

**MATERIAL** Carbon steel zinc plated

#	⊙				⌚	A	B	H	↗	
	DN	size	mm	inch					MPa	psi
1D9EH-08-08	12	-08	12.8	1/2	G 1/2	64	30	27	25	3,625
1D9EH-12-12	20	-12	19.6	3/4	G 3/4	72	33	32	25	3,625
1D9EH-16-16	25	-16	25.0	1	G 1	72	42	41	25	3,625
1D9EH-20-20	32	-20	32.0	1 1/4	G 1 1/4	93	45	50	25	3,625

Design Factor >2:1

Hoses with design factor >2:1

292NC – 2D9NC

## 292NC – BSP female swivel (60° cone)

Field attachable fitting

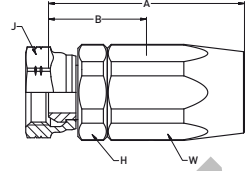

**MATERIAL** Carbon steel zinc plated

#	⊙				⌚	A	B	H	J	W	↻	
	DN	size	mm	inch							MPa	psi
292NC-08-08	12	-08	12.8	1/2	G 1/2	77	37	27	27	27	17	2,465
292NC-12-12	20	-12	19.6	3/4	G 3/4	87	39	36	32	36	17	2,465
292NC-16-16	25	-16	25.0	1	G 1	100	50	46	46	46	17	2,465
292NC-20-20	32	-20	32.0	1 1/4	G 1 1/4	113	60	55	55	55	17	2,465

## 2D9NC – BSP male

Field attachable fitting

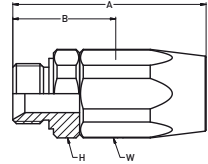

**MATERIAL** Carbon steel zinc plated

#	⊙				⌚	A	B	H	W	↻	
	DN	size	mm	inch						MPa	psi
2D9NC-08-08	12	-08	12.8	1/2	G 1/2	75	35	27	27	17	2,465
2D9NC-12-12	20	-12	19.6	3/4	G 3/4	86	38	36	36	17	2,465
2D9NC-16-16	25	-16	25.0	1	G 1	100	50	46	46	17	2,465
2D9NC-20-20	32	-20	32.0	1 1/4	G 1 1/4	113	60	55	55	17	2,465

Design Factor >2:1

# ESH250plus – Sewer cleaning hose



**CONSTRUCTION**

- Core tube** : Thermoplastic Elastomere
- Pressure reinforcement** : Two braided layers of high tensile synthetic fiber, homogenous compound
- Cover** : Polyurethane, extreme abrasive and cut resistance
- Standard colour** : Green

**TEMPERATURE RANGE** -10°C up to +50°C

#	Ø				Ø		Ø		Burst		Bend		kg/m
	DN	size	mm	inch	mm	MPa	psi	MPa	psi	mm			
ESH250Plus-08	12	-08	12.4	1/2	21.2	25	3,625	62.5	9,060	100	0.24		
ESH250Plus-12	20	-12	19.0	3/4	28.6	25	3,625	62.5	9,060	125	0.40		
ESH250Plus-16	25	-16	25.4	1	36.5	25	3,625	62.5	9,060	150	0.60		
ESH250Plus-20	32	-20	32.0	1 1/4	46.0	25	3,625	62.5	9,060	225	1.00		

## Hose assemblies

#	Length (m)						Fittings	
	Standard					max.	BSP female swivel	BSP male
	80	100	120	160	180			
ESH250Plus-08	•	•	•	•	•	500	G 1/2	G 1/2
ESH250Plus-12	•	•	•	•	•	500	G 3/4	G 3/4
ESH250Plus-16	•	•	•	•	•	500	G 1	G 1
ESH250Plus-20	•	•	•	•	•	400	G 1 1/4	G 1 1/4

### NOTES

- Standard available hose assemblies see table above. Ordering example: ESH250Plus-12-160
- Crimp your own assembly: ESH250Plus available as bulk hose on a drum
- Crimp on a Parkrimp system or on a free adjustable crimper

Hoses with design factor >2:1

192EH – 1D9EH

## 192EH – BSP female swivel (60° cone)

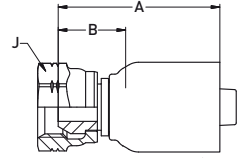

**MATERIAL** Carbon steel zinc plated

#	⊙				⌚	A	B	⬡	↻	
	DN	size	mm	inch					MPa	psi
192EH-08-08	12	-08	12.8	1/2	G 1/2	57	22	27	25	3,625
192EH-12-12	20	-12	19.6	3/4	G 3/4	61	22	32	25	3,625
192EH-16-16	25	-16	25.0	1	G 1	55	25	41	25	3,625
192EH-20-20	32	-20	32.0	1 1/4	G 1 1/4	80	32	50	25	3,625

## 1D9EH – BSP male

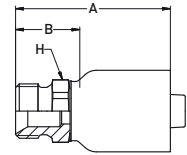

**MATERIAL** Carbon steel zinc plated

#	⊙				⌚	A	B	⬡	↻	
	DN	size	mm	inch					MPa	psi
1D9EH-08-08	12	-08	12.8	1/2	G 1/2	64	30	27	25	3,625
1D9EH-12-12	20	-12	19.6	3/4	G 3/4	72	33	32	25	3,625
1D9EH-16-16	25	-16	25.0	1	G 1	72	42	41	25	3,625
1D9EH-20-20	32	-20	32.0	1 1/4	G 1 1/4	93	45	50	25	3,625

Design Factor >2:1



### 292EJ – BSP female swivel (60° cone)

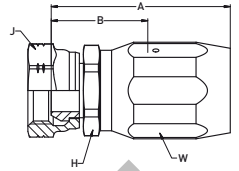

**MATERIAL** Carbon steel zinc plated

#	⊙				⌚	A	B	⬡ H	⬡ J	⬡ W	↻	
	DN	size	mm	inch							MPa	psi
292EJ-8-08	12	-08	12.8	1/2	G 1/2	71	33	27	27	27	18	2,610
292EJ-12-12	20	-12	19.6	3/4	G 3/4	82	37	32	32	36	18	2,610
292EJ-16-16	25	-16	25.0	1	G 1	89	48	41	41	46	18	2,610
292EJ-20-20	32	-20	32.0	1 1/4	G 1 1/4	112	59	50	50	55	18	2,610

### 2D9EJ – BSP male

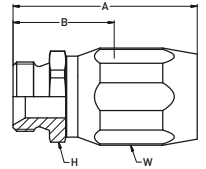

**MATERIAL** Carbon steel zinc plated

#	⊙				⌚	A	B	⬡ H	⬡ W	↻	
	DN	size	mm	inch						MPa	psi
2D9EJ-8-08	12	-08	12.8	1/2	G 1/2	70	32	27	27	18	2,610
2D9EJ-12-12	20	-12	19.6	3/4	G 3/4	83	38	32	36	18	2,610
2D9EJ-16-16	25	-16	25.0	1	G 1	91	50	41	46	18	2,610
2D9EJ-20-20	32	-20	32.0	1 1/4	G 1 1/4	112	59	50	55	18	2,610

Design Factor >2:1

Hoses with design factor >2:1





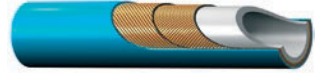

## 2240D-Tough Cover

### 2240D-TOUGH COVER\* – High pressure hose



**CONSTRUCTION** Core tube : Polyoxymethylene  
Pressure reinforcement : Two spiral layers of high tensile steel wire  
Cover : Polyamide  
Standard colour : blue

**TEMPERATURE RANGE** -10°C up to +70°C

#														
	DN	size	mm	inch	mm	MPa	psi	MPa	psi	mm	kg/m			
2240D-02V32-TC	3	-02	3.0	1/8	7.0	110	15,950	275	39,875	60	0.07			
2240D-025V32-TC	4	-025	4.0	5/32	7.7	120	17,400	300	43,500	75	0.10			
2240D-03V32-TC	5	-03	4.8	3/16	9.5	100	14,500	250	36,250	95	0.13			
2240D-04V32-TC	6	-04	6.4	1/4	11.5	110	15,950	275	39,875	110	0.20			

**NOTES** \* Non TOUGH COVER Versions available on request.

## 2248D-TOUGH COVER\* – High pressure hose



**CONSTRUCTION**

- Core tube** : Polyoxymethylene
- Pressure reinforcement** : Two spiral layers of high tensile steel wire
- Cover** : Polyamide
- Standard colour** : blue

**TEMPERATURE RANGE** -10°C up to +70°C

Design Factor >2:1

#	Ø				Ø			⌋		⌋	⌋
	DN	size	mm	inch	mm	MPa	psi	MPa	psi	mm	kg/m
2248D-025V32-TC	4	-025	4.0	5/32	7.9	150	21,750	375	54,375	75	0.10
2248D-03V32-TC	5	-03	4.9	3/16	9.5	140	20,300	350	50,750	95	0.14
2248D-05V32-TC	8	-05	8.1	5/16	13.4	100	14,500	250	36,250	120	0.25

**NOTES** \* Non TOUGH COVER Versions available on request.

Hoses with design factor >2:1

**106TX – 1AYTX**

**106TX – JIC female swivel**

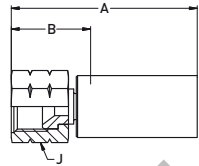

**MATERIAL** Carbon steel zinc plated

#	⊙				⋯	A	B	J	↗		Nipple ID	Ferrule OD
	DN	size	mm	inch					MPa	psi		
106TX-4-02W	3	-02	3.0	1/8	7/16-20 UNF	40	21	17	110	15,950	1.6	9.1
106TX-4-025W	4	-025	4.0	5/32	7/16-20 UNF	44	21	17	150	21,750	2.3	9.9
106TX-6-03W	5	-03	4.8	3/16	9/16-18 UNF	48	25	19	140	20,300	2.8	12.0
106TX-6-04W	6	-04	6.4	1/4	9/16-18 UNF	53	26	19	110	15,950	3.8	13.6

**1AYTX – Type “M” female swivel**

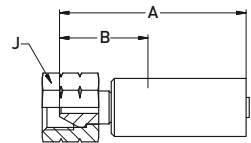

**MATERIAL** Carbon steel zinc plated

#	⊙				⋯	A	B	J	↗		Nipple ID	Ferrule OD
	DN	size	mm	inch					MPa	psi		
1AYTX-6-02W	3	-02	3.0	1/8	9/16-18 UNF	47	28	19	110	15,950	1.6	9.1
1AYTX-6-025W	4	-025	4.0	5/32	9/16-18 UNF	45	23	19	150	21,750	2.3	9.9
1AYTX-6-03W	5	-03	4.8	3/16	9/16-18 UNF	50	23	19	150	21,750	2.8	12.0
1AYTX-6-04W	6	-04	6.4	1/4	9/16-18 UNF	52	25	19	110	15,950	3.8	13.6
1AYTX-8-05W	8	-05	7.9	5/16	3/4-16 UNF	64	30	27	100	14,500	4.8	16.1

Design Factor >2:1

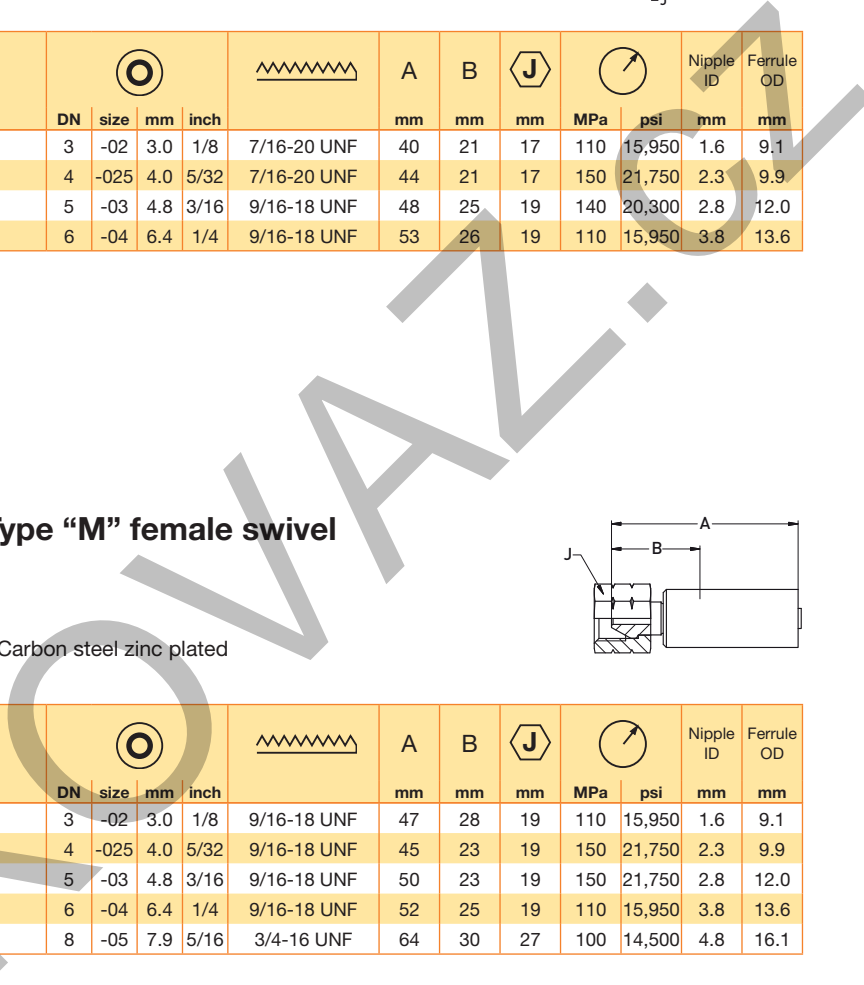

### 1C9TX – Metric female swivel heavy series with O-ring

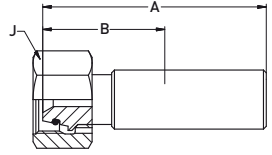

**MATERIAL** Carbon steel zinc plated

**NOTE** \* DN4-6 with support ferrule – DN3 and 8 without support ferrule

#	⊙				⋈	A	B	J	↻		Nipple ID	Ferrule OD
	DN	size	mm	inch					MPa	psi		
1C9TX-16-02W	3	-02	3.0	1/8	M24x1.5	60	39	30	110	15,950	1.6	9.1
1C9TX-16-025W	4	-025	4.0	5/32	M24x1.5	66	35	30	150	21,750	2.3	9.9
1C9TX-16-03W	5	-03	4.8	3/16	M24x1.5	74	42	30	150	21,750	2.8	12.0
1C9TX-10-04W	6	-04	6.4	1/4	M18x1.5	60	33	22	110	15,950	3.8	13.6
1C9TX-16-04W	6	-04	6.4	1/4	M24x1.5	70	44	30	110	15,950	3.8	13.6
1C9TX-12-05W	8	-05	7.9	5/16	M20x1.5	70	31	24	100	14,500	4.8	16.1
1C9TX-14-05W	8	-05	7.9	5/16	M22x1,5	68	29	27	100	14,500	4.8	16.1
1C9TX-16-05W *	8	-05	7.9	5/16	M24x1.5	71	38	30	100	14,500	4.8	16.1

Design Factor >2:1

### 1U0TX – BSP female swivel (ballnose)

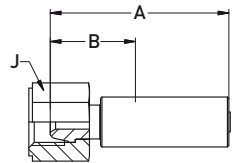

**MATERIAL** Carbon steel zinc plated

#	⊙				⋈	A	B	J	↻		Nipple ID	Ferrule OD
	DN	size	mm	inch					MPa	psi		
1U0TX-2-02W	3	-02	3.0	1/8	G 1/8	36	18	12	110	15,950	1.6	9.1
1U0TX-4-02W	3	-02	3.0	1/8	G 1/4	44	22	17	110	15,950	1.6	9.1
1U0TX-4-025W	4	-025	4.0	5/32	G 1/4	45	23	17	150	21,750	2.3	9.9
1U0TX-4-03W	5	-03	4.7	3/16	G 1/4	49	23	17	150	21,750	2.8	12.0
1U0TX-4-04W	6	-04	6.3	1/4	G 1/4	51	25	17	110	15,950	3.8	13.6
1U0TX-6-05W	8	-05	7.9	5/16	G 3/8	60	26	27	100	14,500	4.8	16.1

Hoses with design factor >2:1

101TX – 102TX

## 101TX – National Pipe Tapered (NPT) male

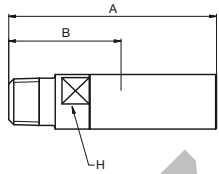

**MATERIAL** → Carbon steel zinc plated

#	⊙				📏	A	B	⊠	↻		Nipple ID	Ferrule OD
	DN	size	mm	inch					MPa	psi		
101TX-1-02W	3	-02	3.0	1/8	1/16 NPT	46	25	10	103.4	15,000	1.6	9.1
101TX-2-02W	3	-02	3.0	1/8	1/8 NPT	44	22	10	103.4	15,000	1.6	9.1
101TX-1-025W	4	-025	4.0	5/32	1/16 NPT	47	25	10	150.0	21,750	2.3	9.9
101TX-2-025W	4	-025	4.0	5/32	1/8 NPT	49	27	10	150.0	21,750	2.3	9.9
101TX-4-025W	4	-025	4.0	5/32	1/4 NPT	56	34	13	150.0	21,750	2.3	9.9
101TX-2-03W	5	-03	4.8	3/16	1/8 NPT	54	27	10	140.0	20,300	2.8	12.0
101TX-4-03W	5	-03	4.8	3/16	1/4 NPT	61	34	13	140.0	20,300	2.8	12.0
101TX-4-04W	6	-04	6.4	1/4	1/4 NPT	62	35	13	140.0	20,300	3.8	13.6
101TX-4-05W	8	-05	7.9	5/16	1/4 NPT	69	35	13	103.4	15,000	4.8	16.1
101TX-6-05W	8	-05	7.9	5/16	3/8 NPT	69	35	17	103.4	15,000	4.8	16.1

## 102TX – National Pipe Tapered (NPT) female

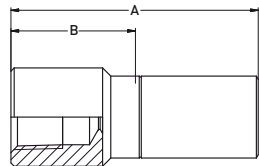

**MATERIAL** → Carbon steel zinc plated

#	⊙				📏	A	B	R	↻		Nipple ID	Ferrule OD
	DN	size	mm	inch					MPa	psi		
102TX-1-025W	4	-025	4.0	5/32	1/16 NPT	45	23	12	103.4	15,000	2.3	9.9
102TX-2-03W	5	-03	4.8	3/16	1/8 NPT	50	23	14	103.4	15,000	2.8	12.0
102TX-4-04W	6	-04	6.4	1/4	1/4 NPT	56	29	19	103.4	15,000	3.8	13.6

Design Factor >2:1

### 6HYPL – Left hand female for water jetting nozzle

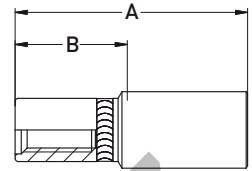

**MATERIAL** Carbon steel zinc plated

**NOTE** \* ProLance fitting; only for 2240D

#						A	B	R			Nipple ID	Ferrule OD
	DN	size	mm	inch					MPa	psi		
6HYPL-1-2*	3	-02	3.0	1/8	12 - 28 UNF	29	13	10	103.4	15,000	1.6	8.4

### 63ZPL / 6ZEPL – Male water jetting nozzle

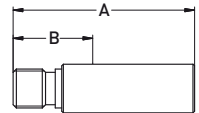

**MATERIAL** Carbon steel zinc plated, C: Stainless steel

**NOTE** \* ProLance fitting; only for 2240D

#						A	B	R			Nipple ID	Ferrule OD
	DN	size	mm	inch					MPa	psi		
63ZPL-5-2A*	3	-02	3.0	1/8	5/16 - 32 UNF	28	11	11	103.4	15,000	2.5	10.1
6ZEPL-5-2A*	3	-02	3.0	1/8	5/16 - 24 UNF	33	18	11	103.4	15,000	2.5	10.1
63ZPL-5-3*	5	-03	4.8	3/16	5/16 - 32 UNF	33	13	13	103.4	15,000	3.2	11.7
63ZPL-5-3C*	5	-03	4.8	3/16	5/16 - 32 UNF	34	9	14	103.4	15,000	3.2	11.7
63ZPL-5-4C*	6	-04	6.4	1/4	5/16 - 32 UNF	71	11	17	103.4	15,000	3.2	13.2

Design Factor >2:1

Hoses with design factor >2:1

**6EZPL – 1YZTX**

**6EZPL – Female water jetting nozzle**

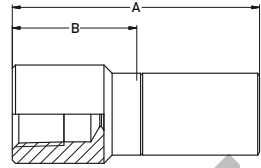

**MATERIAL** Carbon steel zinc plated

**NOTE** \* ProLance fitting; only for 2240D

#	⊙				⌚	A	B	R	↻		Nipple ID	Ferrule OD
	DN	size	mm	inch					MPa	psi		
6EZPL-1-2A*	3	-02	3.0	1/8	12 - 28 UNF	33	17	11	103.4	15,000	2.5	10.1
6EZPL-5-2A*	3	-02	3.0	1/8	5/16 - 24 UNF	38	23	11	103.4	15,000	2.5	10.1

**1YZTX – Metric male nozzle nipple**

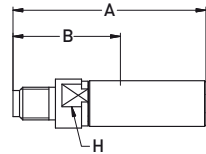

**MATERIAL** Carbon steel zinc plated

#	⊙				⌚	A	B	⬡	↻		Nipple ID	Ferrule OD
	DN	size	mm	inch					MPa	psi		
1YZTX-1-02WS	3	-02	3.0	1/8	M5	49	28	6	110	15,950	1.6	9.1
1YZTX-2-02W	3	-02	3.0	1/8	M7	49	28	7	110	15,950	1.6	9.1
1YZTX-1-025W	4	-025	4.0	5/32	M5	51	29	8	150	21,750	2.3	9.9
1YZTX-2-025W	4	-025	4.0	5/32	M7	51	29	8	150	21,750	2.3	9.9
1YZTX-4-025W	4	-025	4.0	5/32	M8	53	30	8	150	21,750	2.3	9.9
1YZTX-5-025W	4	-025	4.0	5/32	M10x1	52	30	8	150	21,750	2.3	9.9
1YZTX-2-03W	5	-03	4.8	3/16	M7	55	28	10	150	21,750	2.8	12.0
1YZTX-4-03W	5	-03	4.8	3/16	M8	53	28	10	150	21,750	2.8	12.0
1YZTX-5-04W	6	-04	6.4	1/4	M10x1	59	33	13	110	15,950	3.8	13.6
1YZTX-5-05W	8	-05	7.9	5/16	M10x1	68	34	13	100	14,500	4.8	16.1



### 1YBTX – BSP male nozzle nipple

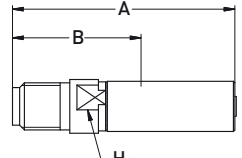

**MATERIAL** Carbon steel zinc plated

#	⊙				⌚	A	B	⬡	↻		Nipple ID	Ferrule OD
	DN	size	mm	inch					MPa	psi		
1YBTX-2-02W	3	-02	3.0	1/8	G 1/8	48	27	8	110	15,950	1.6	9.1
1YBTX-2-025W	4	-025	4.0	5/32	G 1/8	53	30	8	150	21,750	2.3	9.9
1YBTX-4-025W	4	-025	4.0	5/32	G 1/4	54	30	10	150	21,750	2.3	9.9
1YBTX-2-03W	5	-03	4.8	3/16	G 1/8	53	27	10	150	21,750	2.8	12.0
1YBTX-4-03W	5	-03	4.8	3/16	G 1/4	58	31	10	150	21,750	2.8	12.0
1YBTX-2-04W	6	-04	6.4	1/4	G 1/8	60	33	10	110	15,950	3.8	13.6
1YBTX-4-04W	6	-04	6.4	1/4	G 1/4	62	36	10	110	15,950	3.8	13.6
1YBTX-4-05W	8	-05	7.9	5/16	G 1/4	68	35	13	100	14,500	4.8	16.1
1YBTX-6-05W	8	-05	7.9	5/16	G 3/8	71	37	17	100	14,500	4.8	16.1

Design Factor >2:1

### 1YHTX – BSP male nozzle nipple

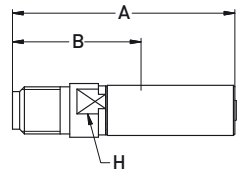

**MATERIAL** Carbon steel zinc plated

#	⊙				⌚	A	B	⬡	↻		Nipple ID	Ferrule OD
	DN	size	mm	inch					MPa	psi		
1YHTX-4-025W	4	-025	4.0	5/32	1/4 - 28 UNF	47	23	8	150	21,750	2.3	9.9
1YHTX-4-025W-LH	4	-025	4.0	5/32	1/4 - 28 UNF LH	47	23	8	150	21,750	2.3	9.9
1YHTX-6-03W	5	-03	4.8	3/16	3/8 - 24 UNF	54	28	11	150	21,750	2.8	12.0
1YHTX-6-03W-LH	5	-03	4.8	3/16	3/8 - 24 UNF LH	54	28	11	150	21,750	2.8	12.0
1YHTX-6-04W	6	-04	6.4	1/4	3/8 - 24 UNF	56	29	11	150	21,750	3.8	13.6
1YHTX-6-04W-LH	6	-04	6.4	1/4	3/8 - 24 UNF LH	56	29	11	150	21,750	3.8	13.6
1YHTX-6-05W	8	-05	7.9	5/16	3/8 - 24 UNF	65	33	13	150	21,750	4.8	16.1
1YHTX-6-05W-LH	8	-05	7.9	5/16	3/8 - 24 UNF LH	65	33	13	150	21,750	4.8	16.1

Hoses with design factor >2:1

2244N

## 2244N – High pressure hose









### CONSTRUCTION

**Core tube** : Polyamide  
**Pressure reinforcement** : Two spiral layers, one braided layer of high tensile steel wire  
**Cover** : Polyurethane  
**Standard colour** : Black





### TEMPERATURE RANGE

-10°C up to +70°C

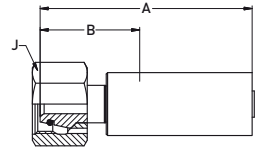



#													
	DN	size	mm	inch	mm	MPa	psi	MPa	psi	mm	kg/m		
2244N-06V10W	10	-06	9.7	3/8	18.0	86	12,470	215	31,175	120	0.50		
2244N-08V10W	12	-08	12.8	1/2	22.7	88	12,760	220	31,900	150	0.80		

NOTES -

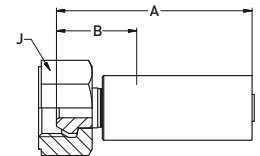
**1C9KX / 1C9LX – Metric female swivel  
heavy series with O-ring****MATERIAL** Special materials

#						A	B				Nipple ID	Ferrule OD
	DN	size	mm	inch					MPa	psi		
1C9KX-14-06W	10	-06	9.5	3/8	M22x1.5	79	37	27	86	12,470	7.0	23.5
1C9LX-16-08	12	-08	12.7	1/2	M24x1.5	88	34	30	130	18,850	6.8	30.0

**192KX / 192LX – BSP female swivel (60° cone)****MATERIAL** Special materials

#						A	B				Nipple ID	Ferrule OD
	DN	size	mm	inch					MPa	psi		
192KX-6-06W	10	-06	9.5	3/8	G3/8	72	29	22	86	12,470	7.0	23.5
192LX-8-08W	12	-08	12.7	1/2	G1/2	75	21	30	130	18,850	6.7	30.7

Hoses with design factor >2:1

1AYKX / 1AYLX

## 1AYKX / 1AYLX – Type “M” female swivel

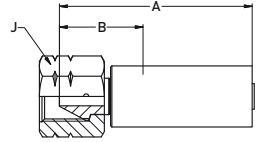

**MATERIAL** Special materials

#	⊙				⋈	A	B	⬡	↗		Nipple ID	Ferrule OD
	DN	size	mm	inch					MPa	psi		
1AYKX-8-06W	10	-06	9.5	3/8	3/4 - 16UNF	74	32	27	86	12,470	7.0	23.5
1AYLX-11-08	12	-08	12.7	1/2	1 - 12 UNF	80	27	32	130	18,850	6.7	30.7

Design Factor >2:1







KOLVANZ

**2380N – High pressure hose**

**CONSTRUCTION**

- Core tube** : Polyamide
- Pressure reinforcement** : Two spiral layers and two open spiral layers of high tensile steel wire
- Cover** : Polyurethane
- Standard colour** : Black

**TEMPERATURE RANGE** -10°C up to +70°C

#													
	DN	size	mm	inch	mm	MPa	psi	MPa	psi	mm	kg/m		
2380N-04V00W	6	-04	6.3	1/4	13.3	110	15,950	280	40,600	70	0.28		
2380N-05V00W	8	-05	8.3	5/16	15.8	100	14,500	250	36,250	90	0.35		

NOTES -







## 2388N – High pressure hose



**CONSTRUCTION**

- Core tube** : Polyamide
- Pressure reinforcement** : Two spiral layers and two open spiral layers of high tensile steel wire
- Cover** : Polyurethane
- Standard colour** : Blue

**TEMPERATURE RANGE** -10°C up to +70°C

#														
	DN	size	mm	inch	mm	MPa	psi	MPa	psi	mm	kg/m			
2388N-04V12W	6	-04	6.3	1/4	13.3	128	18,560	320	46,400	80	0.30			

NOTES -

Design Factor >2:1

KONVINC

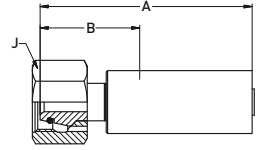
**1C9KY – Metric female swivel heavy series  
with O-ring****MATERIAL** Carbon steel, zinc plated, C: Stainless steel

#	⊙				⋈	A	B	J	⊙		Nipple ID	Ferrule OD
	DN	size	mm	inch					MPa	psi		
1C9KY-10-04	6	-04	6.4	1/4	M18x1.5	68	36	22	110	15,950	3.8	18.0
1C9KY-10-04C	6	-04	6.4	1/4	M18x1.5	68	36	22	110	15,950	3.8	18.0
1C9KY-16-04	6	-04	6.4	1/4	M24x1.5	70	44	30	110	15,950	3.8	18.0
1C9KY-16-04C	6	-04	6.4	1/4	M24x1.5	70	44	30	110	15,950	3.8	18.0
1C9KY-12-05	8	-05	7.9	5/16	M20x1.5	70	31	24	100	14,500	4.9	20.0
1C9KY-14-05	8	-05	7.9	5/16	M22x1.5	68	29	27	100	14,500	4.9	20.0
1C9KY-16-05	8	-05	7.9	5/16	M24x1.5	77	38	30	100	14,500	4.9	20.0

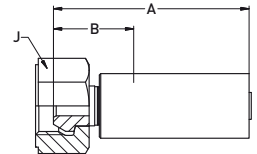
**192KY – BSP female swivel (60° cone)****MATERIAL** Carbon steel, zinc plated, C: Stainless steel

#	⊙				⋈	A	B	J	⊙		Nipple ID	Ferrule OD
	DN	size	mm	inch					MPa	psi		
192KY-6-05	8	-05	7.9	5/16	G 3/8	64	25	27	100	14,500	4.9	20.0

Hoses with design factor >2:1

1AYKY – 1YMKY – 1Y4KY

## 1AYKY – Type “M” female swivel

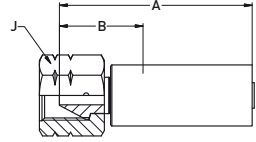

**MATERIAL** Carbon steel, zinc plated, C: Stainless steel

#	⊙				⌚	A	B	J	↻		Nipple ID	Ferrule OD
	DN	size	mm	inch					MPa	psi		
1AYKY-6-04	6	-04	6.4	1/4	9/16 - 18UNF	61	30	22	110	15,950	3.8	18.0
1AYKY-6-04C	6	-04	6.4	1/4	9/16-18 UNF	62	32	22	128	18,560	3.6	18.2
1AYKY-8-05	8	-05	7.9	5/16	3/4 - 16UNF	70	31	27	100	14,500	4.9	20.0

## 1YMKY – High pressure tube nipple metric – LH thread

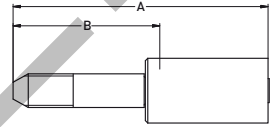

**MATERIAL** High strength carbon steel, zinc plated

#	⊙				⌚	A	B	↻		Nipple ID	Ferrule OD
	DN	size	mm	inch				MPa	psi		
1YMKY-6-05	8	-05	7.9	5/16	M14x1.5-LH	100	61	100	14,500	4.9	20.0

## 1Y4KY – High pressure tube nipple UNF – LH thread

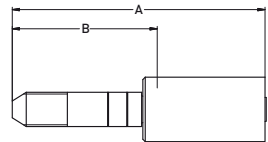

**MATERIAL** Special materials

#	⊙				⌚	A	B	↻		Nipple ID	Ferrule OD
	DN	size	mm	inch				MPa	psi		
1Y4KY-9-05	8	-05	7.9	5/16	9/16 - 18UNF-LH	100	61	100	14,500	4.9	20.0

Design Factor >2:1



### 1U0KY – BSP female swivel (ballnose)

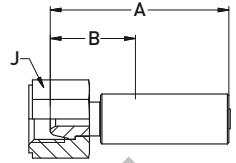

**MATERIAL** Carbon steel zinc plated, C: Stainless steel

#	⊙				⌚	A	B	⬡ J	⦶		Nipple ID	Ferrule OD
	DN	size	mm	inch					MPa	psi		
1U0KY-4-04	6	-04	6.3	1/4	G 1/4	51	25	17	110	15,950	3.8	18.0
1U0KY-4-04C	6	-04	6.3	1/4	G 1/4	51	25	17	110	15,950	3.8	18.0

### 1D9KY – BSP male

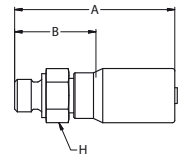

**MATERIAL** Carbon steel, zinc plated, C: Stainless steel

#	⊙				⌚	A	B	⬡ H	⦶		Nipple ID	Ferrule OD
	DN	size	mm	inch					MPa	psi		
1D9KY-4-04	6	-04	6.3	1/4	G 1/4	62	36	19	110	15,950	3.8	18.0
1D9KY-4-04C	6	-04	6.3	1/4	G 1/4	62	36	19	110	15,950	3.8	18.0

Design Factor >2:1

Hoses with design factor >2:1

1YBKY – 101KY – 1TMBS

## 1YBKY – BSP male nozzle nipple

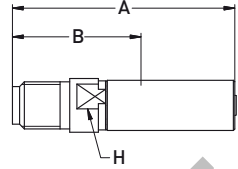

**MATERIAL** Carbon steel zinc plated, C: Stainless steel

#	⊙				⌚	A	B	H	↗		Nipple ID	Ferrule OD
	DN	size	mm	inch					MPa	psi		
1YBKY-4-04	6	-04	6.4	1/4	G 1/4	62	36	10	110	15,950	3.8	18.0
1YBKY-4-04C	6	-04	6.4	1/4	G 1/4	62	36	10	110	15,950	3.8	18.0
1YBKY-4-05	8	-05	7.9	5/16	G 1/4	68	35	13	100	14,500	4.9	20.0
1YBKY-6-05	8	-05	7.9	5/16	G 3/8	71	37	17	100	14,500	4.9	20.0

## 101KY – National Pipe Tapered (NPT) male

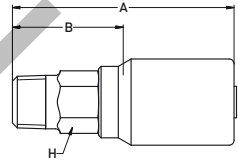

**MATERIAL** Carbon steel zinc plated, C: Stainless steel

#	⊙				⌚	A	B	H	↗		Nipple ID	Ferrule OD
	DN	size	mm	inch					MPa	psi		
101KY-4-04	6	-04	6.4	1/4	1/4 NPT	62	35	13	103.4	15,000	3.8	18.0
101KY-4-04C	6	-04	6.4	1/4	1/4 NPT	62	35	13	103.4	15,000	3.8	18.0
101KY-6-04	6	-04	6.4	1/4	3/8 NPT	67	35	17	103.4	15,000	3.8	18.0
101KY-6-04C	6	-04	6.4	1/4	3/8 NPT	67	35	17	103.4	15,000	3.8	18.0
101KY-4-05	8	-05	7.9	5/16	1/4 NPT	69	35	13	103.4	15,000	4.9	20.0
101KY-6-05	8	-05	7.9	5/16	3/8 NPT	69	35	17	103.4	15,000	4.9	20.0

## 1TMBS – Polyflex Lok components



#	Description
1TMBS-8-05-HPK	Fitting for DN8 hoses incl. caps (refer to pages D-2, D-3)

Design Factor >2:1







## 2380M – High pressure hose



**CONSTRUCTION**

- Core tube** : Polyamide
- Pressure reinforcement** : Two spiral layers and two open spiral layers of high tensile steel wire
- Cover** : Polyurethane
- Standard colour** : Black

**TEMPERATURE RANGE** -10°C up to +120°C

#															
	DN	size	mm	inch	mm	MPa	psi	MPa	psi	mm	kg/m				
2380M-04V30W	6	-04	6.3	1/4	15.8	110	15,950	280	40,600	70	0.28				
2380M-05V30W	8	-05	8.3	5/16	15.8	100	14,500	250	36,250	90	0.35				

NOTES -

Design Factor >2:1

Hoses with design factor >2:1

1C9KX – 192KX – 1AYKX

## 1C9KX – Metric female swivel heavy series with O-ring

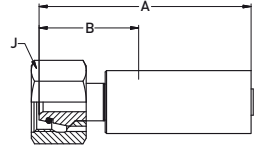

**MATERIAL** Carbon steel, zinc plated

#	⊙				⌚	A	B	J	↗		Nipple ID	Ferrule OD
	DN	size	mm	inch					MPa	psi		
1C9KX-10-04W	6	-04	6.4	1/4	M18x1.5	68	36	22	110	15,950	4.0	17.4
1C9KX-16-05W	8	-05	7.9	5/16	M24x1.5	77	38	30	100	14,500	5.3	20.2

## 192KX – BSP female swivel (60° cone)

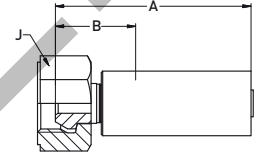

**MATERIAL** Carbon steel, zinc plated

#	⊙				⌚	A	B	J	↗		Nipple ID	Ferrule OD
	DN	size	mm	inch					MPa	psi		
192KX-4-04W	6	-04	6.4	1/4	G 1/4	56	25	19	110	15,950	4.0	17.4
192KX-6-05W	8	-05	7.9	5/16	G 3/8	64	25	27	100	14,500	5.3	20.2

## 1AYKX – Type “M” female swivel

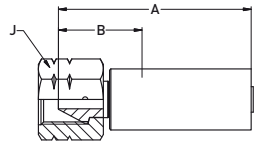

**MATERIAL** Carbon steel, zinc plated

#	⊙				⌚	A	B	J	↗		Nipple ID	Ferrule OD
	DN	size	mm	inch					MPa	psi		
1AYKX-6-04W	6	-04	6.4	1/4	9/16 - 18UNF	61	30	22	110	15,950	4.0	17.4
1AYKX-8-05W	8	-05	7.9	5/16	3/4 - 16UNF	70	31	27	100	14,500	5.3	20.2

Design Factor >2:1

## 2388N – High pressure hose









**CONSTRUCTION**

- Core tube** : Polyamide
- Pressure reinforcement** : Two spiral layers and two open spiral layers of high tensile steel wire
- Cover** : Polyurethane
- Standard colour** : Blue

**TEMPERATURE RANGE** -10°C up to +70°C

Design Factor >2:1

#												
	DN	size	mm	inch	mm	MPa	psi	MPa	psi	mm	kg/m	
2388N-08V12W	12	-08	13.0	1/2	23.0	110	15,950	275	39,875	100	0.80	

NOTES -

## 101BS – National Pipe Tapered (NPT) male

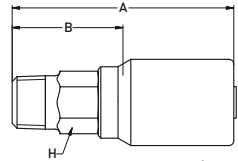

**MATERIAL** Carbon steel, zinc plated, C: Stainless steel

#	⊙				📏	A	B	⬡	↻		Nipple ID	Ferrule OD
	DN	size	mm	inch					MPa	psi		
101BS-8-08	12	-08	12.7	1/2	1/2 NPT	93	40	22	103.5	15,000	7.6	28.5
101BS-8-08C	12	-08	12.7	1/2	1/2 NPT	93	40	22	103.5	15,000	7.6	28.5

## 192BS – BSP female swivel (60° cone)

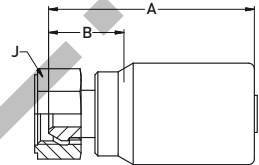

**MATERIAL** Carbon steel, zinc plated, C: Stainless steel

#	⊙				📏	A	B	⬡	↻		Nipple ID	Ferrule OD
	DN	size	mm	inch					MPa	psi		
192BS-8-08	12	-08	12.7	1/2	G1/2	81	28	27	110	15,950	7.6	28.5
192BS-8-08C	12	-08	12.7	1/2	G1/2	81	28	27	110	15,950	7.6	28.5

## 1C9BS – Metric female swivel heavy series with O-ring

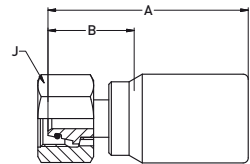

**MATERIAL** Carbon steel, zinc plated, C: Stainless steel

#	⊙				📏	A	B	⬡	↻		Nipple ID	Ferrule OD
	DN	size	mm	inch					MPa	psi		
1C9BS-14-08	12	-08	12.7	1/2	M22x1.5	89	36	27	110	15,950	7.6	28.5
1C9BS-14-08C	12	-08	12.7	1/2	M22x1.5	89	36	27	110	15,950	7.6	28.5
1C9BS-16-08	12	-08	12.7	1/2	M24x1.5	89	36	30	110	15,950	7.6	28.5
1C9BS-16-08C	12	-08	12.7	1/2	M24x1.5	89	36	30	110	15,950	7.6	28.5

Design Factor >2:1

### 1AYBS – Type “M” female swivel

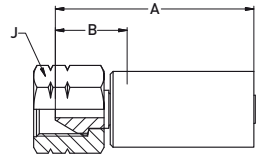

**MATERIAL** Carbon steel, zinc plated, C: Stainless steel

#						A	B				Nipple ID	Ferrule OD
	DN	size	mm	inch					MPa	psi		
1AYBS-11-08	12	-08	12,7	1/2	1 - 12 UNF	77	31	32	110	15,950	7.6	28.5
1AYBS-11-08C	12	-08	12,7	1/2	1 - 12 UNF	77	31	32	110	15,950	7.6	28.5

### 1TMBS – Polyflex Lok components



#	Description
1TMBS-9-08-HPK	Fitting for DN12 hoses incl. caps (refer to pages D-2, D-3)

Design Factor >2:1

KOVAMA







## 2580N – High pressure hose



**CONSTRUCTION**

- Core tube** : Polyamide
- Pressure reinforcement** : Four spiral layers and two open spiral layers of high tensile steel wire
- Cover** : Polyurethane
- Standard colour** : Dark blue

**TEMPERATURE RANGE** -10°C up to +70°C

#													
	DN	size	mm	inch	mm	MPa	psi	MPa	psi	mm	kg/m		
2580N-06V12	10	-06	9.8	3/8	21.6	160	23,200	400	58,000	95	0.94		
2580N-08V12	12	-08	12.9	1/2	25.0	140	20,300	350	50,750	110	1.19		
2580N-12V12	20	-12	19.8	3/4	32.6	120	17,400	300	43,500	170	1.76		

NOTES -

Design Factor >2:1

KONING



## 101BL – National Pipe Tapered (NPT) male

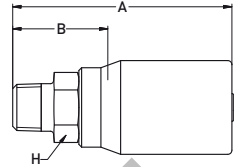

**MATERIAL** Carbon steel, zinc plated, C: Stainless steel

#	⊙				📐	A	B	⬡	⊙		Nipple ID	Ferrule OD
	DN	size	mm	inch					MPa	psi		
101BL-6-06	10	-06	9.5	3/8	3/8 NPT	80	35	22	160	23,200	5.5	28.5
101BL-8-08	12	-08	12.7	1/2	1/2 NPT	90	45	22	140	20,300	7.5	30.5
101BL-8-08C	12	-08	12.7	1/2	1/2 NPT	90	45	22	140	20,300	7.5	30.5
101BL-12-12	20	-12	19.0	3/4	3/4 NPT	98	45	30	120	17,400	12.5	39.8

## 192BL – BSP female swivel (60° cone)

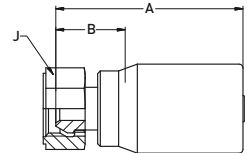

**MATERIAL** Carbon steel, zinc plated, C: Stainless steel

#	⊙				📐	A	B	⬡	⊙		Nipple ID	Ferrule OD
	DN	size	mm	inch					MPa	psi		
192BL-6-06	10	-06	9.5	3/8	G3/8	68	24	22	160	23,200	5.5	28.5
192BC-8-06	10	-06	9.5	3/8	G1/2	71	26	27	160	23,200	5.5	28.5
192BL-8-08	12	-08	12.7	1/2	G1/2	71	26	27	140	20,300	7.5	30.5
192BL-8-08C	12	-08	12.7	1/2	G1/2	71	26	27	140	20,300	7.5	30.5
192BL-16-12	20	-12	19.0	3/4	G1	82	28	41	120	17,400	12.5	39.8



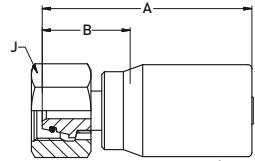

Hoses with design factor >2:1

1C9BL – 1AYBL – 1TMBL

## 1C9BL – Metric female swivel heavy series with O-ring





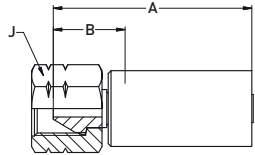

**MATERIAL** Carbon steel, zinc plated, C: Stainless steel

#							A	B			Nipple ID	Ferrule OD	
	DN	size	mm	inch									mm
1C9BL-14-06	10	-06	9.5	3/8	M22 x 1.5	14	80	36	30	160	23,200	5.5	28.5
1C9BL-16-06	10	-06	9.5	3/8	M24 x 1.5	16	84	36	30	160	23,200	5.5	28.5
1C9BL-14-08	12	-08	12.7	1/2	M22 x 1.5	14	80	36	27	140	20,300	7.5	30.5
1C9BL-14-08C	12	-08	12.7	1/2	M22 x 1.5	14	80	36	27	140	20,300	7.5	30.5
1C9BL-16-08	12	-08	12.7	1/2	M24 x 1.5	16	80	36	30	140	20,300	7.5	30.5
1C9BL-16-08C	12	-08	12.7	1/2	M24 x 1.5	16	80	36	30	140	20,300	7.5	30.5
1C9BL-25-12	20	-12	19.0	3/4	M36 x 2.0	25	97	44	46	120	17,400	12.5	39.8

## 1AYBL – Type “M” female swivel



**MATERIAL** Carbon steel, zinc plated, C: Stainless steel

#						A	B			Nipple ID	Ferrule OD	
	DN	size	mm	inch								mm
1AYBL-11-06	10	-06	9.5	3/8	1 - 12 UNF	77	31	32	160	23,200	5.5	28.5
1AYBL-11-08	12	-08	12.7	1/2	1 - 12 UNF	77	31	32	140	20,300	7.5	30.5
1AYBL-11-08C	12	-08	12.7	1/2	1 - 12 UNF	77	31	32	140	20,300	7.5	30.5

## 1TMBL – Polyflex Lok components



#	Description
1TMBL-9-08-HPK	Fitting for DN12 hoses incl. caps (refer to pages D-2, D-3)

Design Factor >2:1

## 2440D / 2440N – Ultra-high pressure hose



**CONSTRUCTION**

**Core tube** : DN 3-8: Polyoxymethylene; DN 10-25: Polyamide  
**Pressure reinforcement** : Four spiral layers of maximum tensile steel wire

**Cover** : Polyamide  
**Standard colour** : DN 3-8: blue; DN 10-25: black

**TEMPERATURE RANGE** -10°C up to +70°C

#												
	DN	size	mm	inch	mm	MPa	psi	MPa	psi	mm		
2440D-02V32	3	-02	3.0	1/8	7.9	207	30,000	518	75,000	100	0.12	
2440D-025V32	4	-025	4.0	5/32	10.4	220	31,900	550	79,750	100	0.21	
2440D-03V32	5	-03	4.8	3/16	11.5	180	26,100	450	65,250	130	0.28	
2440D-04V32	6	-04	6.4	1/4	12.5	164	23,780	410	59,450	155	0.33	
2440D-05V32	8	-05	8.1	5/16	15.1	150	21,750	375	54,375	175	0.44	
2440N-06V30	10	-06	9.7	3/8	19.4	140	20,300	350	50,750	190	0.73	
2440N-08V30	12	-08	12.8	1/2	22.5	130	18,850	325	47,125	200	0.94	
2440N-12V30	20	-12	19.6	3/4	30.0	100	14,500	250	36,250	250	1.39	
2440N-16V30	25	-16	25.0	1	37.0	90	13,050	225	32,625	300	2.00	

NOTES -

Hoses with design factor >2:1

**2440D-Tough Cover**

**2440D-TOUGH COVER – Ultra-high pressure hose**



**CONSTRUCTION** Core tube : Polyoxymethylene  
 Pressure reinforcement : Four spiral layers of maximum tensile steel wire  
 Cover : Polyamide  
 Standard colour : blue

**TEMPERATURE RANGE** -10°C up to +70°C

#	Ø				Ø			Ø		Ø	kg/m
	DN	size	mm	inch	mm	MPa	psi	MPa	psi		
2440D-025V32-TC	4	-025	3.9	5/32	10.4	220	31,900	550	79,750	100	0.21
2440D-03V32-TC	5	-03	4.7	3/16	11.5	180	26,100	450	65,250	130	0.28
2440D-04V32-TC	6	-04	6.3	1/4	12.5	164	23,780	410	59,450	155	0.33
2440D-05V32-TC	8	-05	8.0	5/16	15.1	150	21,750	375	54,375	175	0.44
2440N-06V30-TC	10	-06	9.7	3/8	19.4	140	20,300	350	50,750	190	0.73
2440N-08V30-TC	12	-08	12.8	1/2	22.5	130	18,850	325	47,125	200	0.94

NOTES -

Design Factor >2:1

# 1C9LX – Metric female swivel heavy series with O-ring

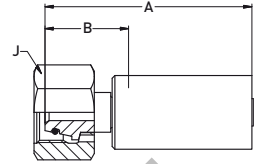

**MATERIAL** High strength carbon steel, zinc plated, C: Stainless steel

#	⊙				⌚	A	B	J	⊙		Nipple ID	Ferrule OD
	DN	size	mm	inch					MPa	psi		
1C9LX-8-025	4	-025	4.0	5/32	M16x1.5	67	30	22	220	31,900	1.4	14.6
1C9LX-14-03	5	-03	4.8	3/16	M22x1.5	75	33	30	180	26,100	1.4	15.3
1C9LX-16-03	5	-03	4.8	3/16	M24x1.5	80	38	30	180	26,100	1.4	15.3
1C9LX-10-04	6	-04	6.4	1/4	M18x1.5	76	31	27	164	23,780	2.9	17.0
1C9LX-16-04	6	-04	6.4	1/4	M24x1.5	85	40	30	164	23,780	2.9	17.0
1C9LX-12-05	8	-05	7.9	5/16	M20x1.5	78	34	27	150	21,750	3.7	21.0
1C9LX-14-05	8	-05	7.9	5/16	M22x1.5	84	40	30	150	21,750	3.7	21.0
1C9LX-16-05	8	-05	7.9	5/16	M24x1.5	84	40	30	150	21,750	3.7	21.0
1C9LX-16-05C	8	-05	7.9	5/16	M24x1.5	84	40	30	150	21,750	3.7	21.0
1C9LX-12-06	10	-06	9.5	3/8	M20x1.5	76	30	27	140	20,300	5.8	26.9
1C9LX-14-06	10	-06	9.5	3/8	M22x1.5	76	30	30	140	20,300	5.8	26.9
1C9LX-14-06C	10	-06	9.5	3/8	M22x1.5	76	30	30	140	20,300	5.8	26.9
1C9LX-16-06	10	-06	9.5	3/8	M24x1.5	80	34	30	140	20,300	5.8	26.9
1C9LX-16-06C	10	-06	9.5	3/8	M24x1.5	80	34	30	140	20,300	5.8	26.9
1C9LX-16-08	12	-08	12.7	1/2	M24x1.5	88	34	30	130	18,850	6.7	30.7
1C9LX-16-08C	12	-08	12.7	1/2	M24x1.5	88	34	30	130	18,850	6.7	30.7
1C9LX-25-12	20	-12	19.0	3/4	M36x2	92	39	46	100	14,500	12.7	38.5
1C9LX-25-12C4462	20	-12	19.0	3/4	M36x2	92	39	46	100	14,500	12.7	38.5
1C9LX-30-16	25	-16	25.4	1	M42x2	98	45	50	90	13,050	17.2	45.3
6C9LX-30-16C	25	-16	25.4	1	M42x2	118	52	50	90	13,050	17.2	45.3

Design Factor >2:1

Hoses with design factor >2:1

6AYLX / 1AYLX – 1YMLX

## 6AYLX / 1AYLX – Type “M” female swivel

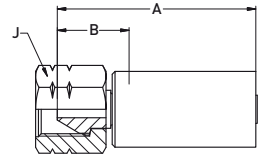

**MATERIAL** High strength carbon steel, zinc plated, C: Stainless steel

#	⊙				⋈	A	B	J	↻		Nipple ID	Ferrule OD
	DN	size	mm	inch					MPa	psi		
1AYLX-6-02	3	-02	3.0	1/8	9/16 - 18UNF	48	26	22	207	30,000	1.5	9.8
6AYLX-6-2AC	4	-025	4.0	5/32	9/16 - 18 UNF	64	33	17	301	43,645	1.6	13.2
1AYLX-6-025	4	-025	4.0	5/32	9/16 - 18 UNF	64	33	22	220	31,900	1.4	14.6
1AYLX-6-03	5	-03	4.8	3/16	9/16 - 18UNF	66	26	22	180	26,100	1.4	15.3
1AYLX-6-03C	5	-03	4.8	3/16	9/16 - 18 UNF	67	26	22	180	26,100	1.4	15.3
1AYLX-6-04	6	-04	6.4	1/4	9/16 - 18UNF	61	29	22	164	23,780	2.9	17.0
1AYLX-6-04C	6	-04	6.4	1/4	9/16 - 18UNF	61	29	22	164	23,780	2.9	17.0
1AYLX-8-05	8	-05	7.9	5/16	3/4 - 16UNF	74	30	27	150	21,750	3.7	21.0
1AYLX-8-05C	8	-05	7.9	5/16	3/4 - 16 UNF	70	31	27	150	21,750	3.7	21.0
1AYLX-8-06	10	-06	9.5	3/8	3/4 - 16UNF	70	26	27	140	20,300	5.8	26.9
1AYLX-8-06C	10	-06	9.5	3/8	3/4 - 16 UNF	70	25	27	140	20,300	5.8	26.9
1AYLX-11-08	12	-08	12.7	1/2	1 - 12 UNF	80	27	32	130	18,850	6.7	30.7
1AYLX-11-08C	12	-08	12.7	1/2	1 - 12 UNF	80	27	32	130	18,850	6.7	30.7
1AYLX-16-12	20	-12	19.0	3/4	1 5/16-12UNF	82	29	41	100	14,500	12.7	38.5
1AYLX-16-12C4462	20	-12	19.0	3/4	1 5/16-12 UNF	82	29	41	100	14,500	12.7	38.5
6AYLX-16-16C	25	-16	25.4	1	1 5/16 - 12 UNF	100	47	38	90	13,050	17.2	45.3

## 1YMLX – High pressure tube nipple metric – LH thread

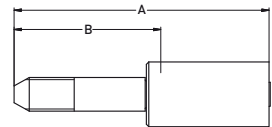

**MATERIAL** High strength carbon steel, zinc plated, C: Stainless steel

#	⊙				⋈	A	B	↻		Nipple ID	Ferrule OD
	DN	size	mm	inch				MPa	psi		
1YMLX-6-025	4	-025	4.0	5/32	M14x1.5-LH	103	66	220	31,900	1.4	14.6
1YMLX-6-05	8	-05	7.9	5/16	M14x1.5-LH	110	66	150	21,750	3.7	21.0
1YMLX-11-08	12	-08	12.7	1/2	M18x1.5-LH	120	65	250	36,250	6.7	30.7
1YMLX-11-12C4462	20	-12	19.0	3/4	M18x1.5-LH	122	69	250	36,250	12.7	38.5

**1YALX / 1Y4LX – High pressure tube nipple  
 UNF – LH thread**

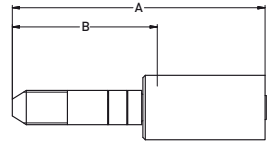

**MATERIAL** Special materials, C: Stainless steel

#						A	B			Nipple ID	Ferrule OD
	DN	size	mm	inch				mm	mm		
1YALX-1-025	4	-025	4.0	5/32	1/4 - 28UNF-LH	87	50	220	31,900	1.4	14.6
1YALX-1-025C	4	-025	4.0	5/32	1/4 - 28UNF-LH	87	50	220	31,900	1.4	14.6
1YALX-3-025	4	-025	4.0	5/32	3/8 - 24UNF-LH	89	50	220	31,900	1.4	14.6
1YALX-1-03	5	-03	4.8	3/16	1/4 - 28UNF-LH	92	53	180	26,100	1.4	15.3
1YALX-1-03C	5	-03	4.8	3/16	1/4 - 28UNF-LH	92	53	180	26,100	1.4	15.3
1YALX-3-03	5	-03	4.8	3/16	3/8 - 24UNF-LH	99	57	180	26,100	1.4	15.3
1YALX-3-03C	5	-03	4.8	3/16	3/8 - 24UNF-LH	99	57	180	26,100	1.4	15.3
1YALX-6-03	5	-03	4.8	3/16	9/16 - 18UNF-LH	108	78	180	26,100	1.4	15.3
1YALX-6-03C	5	-03	4.8	3/16	9/16 - 18UNF-LH	108	78	180	26,100	1.4	15.3
1YALX-3-04	6	-04	6.4	1/4	3/8 - 24UNF-LH	102	58	164	23,780	2.9	17.0
1YALX-6-04	6	-04	6.4	1/4	9/16 - 18UNF-LH	112	67	164	23,780	2.9	17.0
1YALX-3-05C	8	-05	7.9	5/16	3/8 - 24UNF-LH	103	59	150	21,750	3.7	21.0
1YALX-6-05	8	-05	7.9	5/16	9/16 - 18UNF-LH	110	66	150	21,750	3.7	21.0
1YALX-6-05C	8	-05	7.9	5/16	9/16 - 18UNF-LH	110	66	150	21,750	3.7	21.0
1YALX-6-06	10	-06	9.5	3/8	9/16 - 18UNF-LH	106	62	140	20,300	5.8	26.9

Design Factor >2:1



Hoses with design factor >2:1

192LX / 692LX – 1Y9LX

## 192LX / 692LX – BSP female swivel (60° cone)

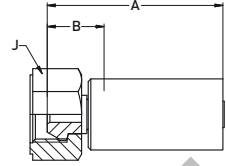

**MATERIAL** High strength carbon steel, zinc plated, C: Stainless steel

#	⊙				⋈	A	B	⬡	↻		Nipple ID	Ferrule OD
	DN	size	mm	inch					MPa	psi		
192LX-4-03	5	-03	4.8	3/16	G 1/4	64	25	22	180	26,100	1.4	15.3
192LX-4-03C	5	-03	4.8	3/16	G 1/4	64	25	22	180	26,100	1.4	15.3
192LX-6-05	8	-05	7.9	5/16	G 3/8	69	25	27	150	21,750	3.7	21.0
192LX-6-05C	8	-05	7.9	5/16	G 3/8	69	25	27	150	21,750	3.7	21.0
192LX-8-06	10	-06	9.5	3/8	G 1/2	66	22	30	140	20,300	5.8	26.9
192LX-8-06C	10	-06	9.5	3/8	G 1/2	66	22	30	140	20,300	5.8	26.9
192LX-8-08	12	-08	12.7	1/2	G 1/2	75	21	30	130	18,850	6.7	30.7
192LX-8-08C	12	-08	12.7	1/2	G 1/2	75	21	30	130	18,850	6.7	30.7
192LX-12-08C	12	-08	12.7	1/2	G 3/4	85	30	32	130	18,850	6.7	30.7
192LX-16-12	20	-12	19.0	3/4	G 1	77	24	41	100	14,500	12.7	38.5
192LX-16-12C4462	20	-12	19.0	3/4	G 1	77	24	41	100	14,500	12.7	38.5
192LX-20-16	25	-16	25.4	1	G 1 1/4	78	25	50	90	13,050	17.2	45.3
692LX-16-16C	25	-16	25.4	1	G 1 1/4	78	25	50	90	13,050	17.2	45.3

## 1Y9LX – BSP male for USIT ring

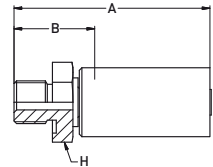

**MATERIAL** High strength carbon steel, zinc plated, C: Stainless steel

#	⊙				⋈	A	B	⬡	↻		Nipple ID	Ferrule OD
	DN	size	mm	inch					MPa	psi		
1Y9LX-4-03	5	-03	4.8	3/16	G 1/4	72	32	22	180	26,100	1.4	15.3
1Y9LX-4-03C	5	-03	4.8	3/16	G 1/4	72	32	22	180	26,100	1.4	15.3
1Y9LX-6-05	8	-05	7.9	5/16	G 3/8	82	38	27	150	21,750	3.7	21.0
1Y9LX-8-08	12	-08	12.7	1/2	G 1/2	87	32	36	130	18,850	6.7	30.7



### 1D9LX – BSP male

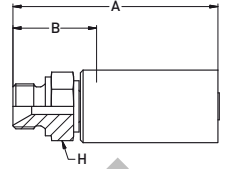

**MATERIAL** High strength carbon steel, zinc plated

#	⊙				⌚	A	B	⬡	⦶		Nipple ID	Ferrule OD
	DN	size	mm	inch					MPa	psi		
1D9LX-4-025	4	-025	4.0	5/32	G 1/4	73	36	19	220	31,900	1.4	14.6
1D9LX-4-03	5	-03	4.8	3/16	G 1/4	77	35	19	180	26,100	1.4	15.3
1D9LX-4-04	6	-04	6.4	1/4	G 1/4	80	36	19	164	23,780	2.9	17.0
1D9LX-4-05	8	-05	7.9	5/16	G 1/4	77	33	19	150	21,750	3.7	21.0
1D9LX-4-06	10	-06	9.5	3/8	G 1/4	76	30	19	140	20,300	5.8	26.9

### 1C3LX – Metric female swivel light series

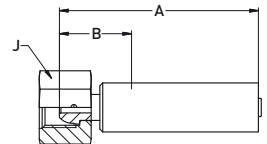

**MATERIAL** High strength carbon steel, zinc plated, C: Stainless steel

#	⊙				⌚	A	B	⬡	⦶		Nipple ID	Ferrule OD
	DN	size	mm	inch					MPa	psi		
1C3LX-8-025	4	-025	4.0	5/32	M14x1,5	63	26	22	220	31,900	1.4	14.6
1C3LX-8-03	5	-03	4.8	3/16	M14x1.5	64	25	22	180	26,100	1.4	15.3
1C3LX-8-03C	5	-03	4.8	3/16	M14x1.5	64	25	22	180	26,100	1.4	15.3
1C3LX-8-04	6	-04	6.4	1/4	M14x1.5	69	25	22	164	23,780	2.9	17.0
1C3LX-8-04C	6	-04	6.4	1/4	M14x1.5	69	25	22	164	23,780	2.9	17.0

Design Factor >2:1

Hoses with design factor >2:1

**1C6LX – 1MRLX**

**1C6LX – Metric female swivel heavy series**

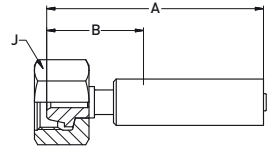

**MATERIAL** High strength carbon steel, zinc plated

#	⊙				~~~~~	A	B	J	↗		Nipple ID	Ferrule OD
	DN	size	mm	inch					MPa	psi		
1C6LX-12-04	6	-04	6.4	1/4	M20x1,5	80	36	27	164	23,780	2.9	17.0
1C6LX-12-05	8	-05	7.9	5/16	M20x1.5	78	34	27	150	21,750	3.7	21.0

**1MRLX – Metric female swivel 59° cone**

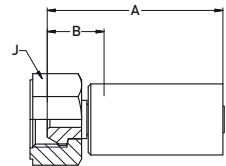

**MATERIAL** High strength carbon steel, zinc plated

#	⊙				~~~~~	A	B	J	↗		Nipple ID	Ferrule OD
	DN	size	mm	inch					MPa	psi		
1MRLX-6-03	5	-03	4.8	3/16	M12x1.5	92	53	17	180	26,100	1.4	15.3
1MRLX-8-03	5	-03	4.8	3/16	M14x1.5	66	26	22	180	26,100	1.4	15.3

Design Factor >2:1

# 101LX / 601LX – National Pipe Tapered (NPT) male

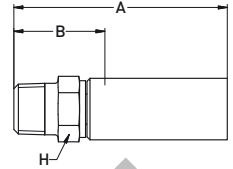

**MATERIAL** Special materials, C: Stainless steel

#	⊙				⌚	A	B	⬡	⊙		Nipple ID	Ferrule OD
	DN	size	mm	inch					MPa	psi		
101LX-2-025	4	-025	4.0	5/32	1/8 NPT	68	30	14	103.4	15,000	1.4	14.6
101LX-4-03	5	-03	4.8	3/16	1/4 NPT	75	33	14	103.4	15,000	1.4	15.3
101LX-2-04	6	-04	6.4	1/4	1/8 NPT	75	30	14	103.4	15,000	2.9	17.0
101LX-4-04	6	-04	6.4	1/4	1/4 NPT	80	36	14	103.4	15,000	2.9	17.0
101LX-4-04C	6	-04	6.4	1/4	1/4 NPT	80	36	14	103.4	15,000	2.9	17.0
101LX-6-04	6	-04	6.4	1/4	3/8 NPT	80	36	19	103.4	15,000	2.9	17.0
101LX-4-05	8	-05	7.9	5/16	1/4 NPT	76	31	14	103.4	15,000	3.7	21.0
101LX-4-05C	8	-05	7.9	5/16	1/4 NPT	76	31	14	103.4	15,000	3.7	21.0
101LX-6-05	8	-05	7.9	5/16	3/8 NPT	75	35	19	103.4	15,000	3.7	21.0
101LX-6-05C	8	-05	7.9	5/16	3/8 NPT	81	36	19	103.4	15,000	3.7	21.0
101LX-6-06	10	-06	9.5	3/8	3/8 NPT	76	30	19	103.4	15,000	5.8	26.9
101LX-8-06	10	-06	9.5	3/8	1/2 NPT	81	35	22	103.4	15,000	5.8	26.9
101LX-8-06C	10	-06	9.5	3/8	1/2 NPT	81	35	22	103.4	15,000	5.8	26.9
101LX-8-08	12	-08	12.7	1/2	1/2 NPT	91	37	22	103.4	15,000	6.7	30.7
101LX-8-08C	12	-08	12.7	1/2	1/2 NPT	91	37	22	103.4	15,000	6.7	30.7
101LX-12-12	20	-12	19.0	3/4	3/4 NPT	124	57	35	69.0	10,000	12.7	38.5
101LX-16-16	25	-16	25.4	1	1 NPT	125	64	35	69.0	10,000	17.2	45.3
601LX-16-16C	25	-16	25.4	1	1 NPT	125	64	35	69.0	10,000	17.2	45.3

Design Factor >2:1

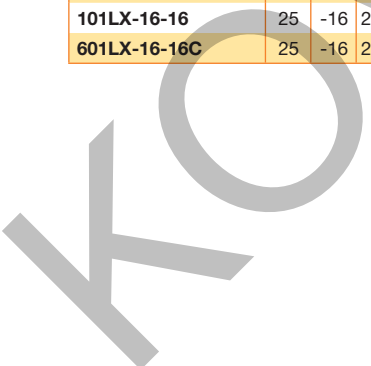

Hoses with design factor >2:1

6YHLX

## 6YHLX – UNF male nozzle nipple

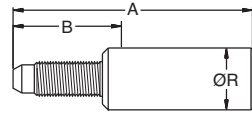

**MATERIAL** Special materials, C: Stainless steel

**NOTE** \*ProLance fitting

#	⊙				⌚	A	B	R	↗		Nipple ID	Ferrule OD
	DN	size	mm	inch					MPa	psi		
6YHLX-4-2AC-PL*	4	-025	4.0	5/32	1/4 - 28 UNF	58	26	8	280	40,600	1.6	11.6
6YHLX-4-2AC-PL-LH*	4	-025	4.0	5/32	1/4 - 28 UNF LH	58	26	8	280	40,600	1.6	11.6
6YHLX-4-3C-PL*	5	-03	4.8	3/16	1/4 - 28 UNF	62	29	10	280	40,600	2.1	12.5
6YHLX-4-3C-PL-LH*	5	-03	4.8	3/16	1/4 - 28 UNF LH	62	29	10	280	40,600	2.1	12.5
6YHLX-6-3C-PL*	5	-03	4.8	3/16	3/8 - 24 UNF	65	32	10	250	36,250	2.1	12.5
6YHLX-6-3C-PL-LH*	5	-03	4.8	3/16	3/8 - 24 UNF LH	65	32	10	250	36,250	2.1	12.5
6YHLX-6-4C-PL*	6	-04	6.4	1/4	3/8 - 24 UNF	66	36	11	250	36,250	3.4	15.0
6YHLX-6-4C-PL-LH*	6	-04	6.4	1/4	3/8 - 24 UNF LH	66	36	11	250	36,250	3.4	15.0
6YHLX-9-5C-PL*	8	-05	7.9	5/16	9/16 - 18 UNF	80	36	16	137.9	20,000	4.3	17.4
6YHLX-9-5C-PL-LH*	8	-05	7.9	5/16	9/16 - 18 UNF	80	36	16	137.9	20,000	4.3	17.4

## 6HYLX – UNF female for water jetting nozzle

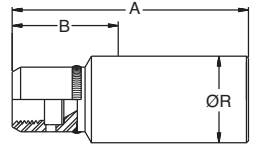

**MATERIAL** Special materials, C: Stainless steel

**NOTE** \*ProLance fitting

#						A	B	R			Nipple ID	Ferrule OD
	DN	size	mm	inch					MPa	psi		
6HYLX-4-2AC-PL*	4	-025	4.0	5/32	1/4 - 28 UNF	51	19	9	280	40,600	1.6	11.6
6HYLX-4-2AC-PL-LH*	4	-025	4.0	5/32	1/4 - 28 UNF LH	51	19	9	280	40,600	1.6	11.6
6HYLX-6-2AC-PL-LH*	4	-025	4.0	5/32	3/8 - 24 UNF-LH	49	21	11	280	40,600	1.6	11.6
6HYLX-4-3C-PL*	5	-03	4.8	3/16	1/4 - 28 UNF	52	19	9	280	40,600	2.1	12.5
6HYLX-4-3C-PL-LH*	5	-03	4.8	3/16	1/4 - 28 UNF LH	52	19	9	280	40,600	2.1	12.5
6HYLX-6-3C-PL*	5	-03	4.8	3/16	3/8 - 24 UNF	56	23	11	250	36,250	2.1	12.5
6HYLX-6-3C-PL-LH*	5	-03	4.8	3/16	3/8 - 24 UNF LH	56	23	11	250	36,250	2.1	12.5
6HYLX-6-4C-PL*	6	-04	6.4	1/4	3/8 - 24 UNF	58	25	11	250	36,250	3.4	15.0
6HYLX-6-4C-PL-LH*	6	-04	6.4	1/4	3/8 - 24 UNF LH	58	25	11	250	36,250	3.4	15.0
6HYLX-9-5C-PL*	8	-05	7.9	5/16	9/16 - 18 UNF	72	28	17	137.9	20,000	4.3	17.4
6HYLX-9-5C-PL-LH*	8	-05	7.9	5/16	9/16 - 18 UNF	72	28	17	137.9	20,000	4.3	17.4

Design Factor >2:1

KOVAT

Hoses with design factor >2:1

66YLX – 65YLX

## 66YLX – High pressure female swivel

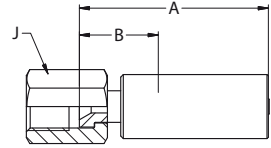

**MATERIAL** Special materials, C: Stainless steel

#	⊙				⋈	A	B	J	↻		Nipple ID	Ferrule OD
	DN	size	mm	inch					MPa	psi		
66YLX-4-3	5	-03	4.8	3/16	9/16 - 18 UNF	71	33	19	180	26,100	2.1	15.0
66YLX-4-3C	5	-03	4.8	3/16	9/16 - 18 UNF	74	36	17	180	26,100	2.1	15.0

## 65YLX – Medium pressure female swivel

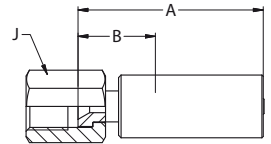

**MATERIAL** Special materials, C: Stainless steel

#	⊙				⋈	A	B	J	↻		Nipple ID	Ferrule OD
	DN	size	mm	inch					MPa	psi		
65YLX-6-3	5	-03	4.8	3/16	9/16 - 18	78	39	19	137.9	20,000	2.1	15.0
65YLX-6-3C	5	-03	4.8	3/16	9/16 - 18	78	39	19	137.9	20,000	2.1	15.0
65YLX-6-4	6	-04	6.4	1/4	9/16 - 18	72	39	19	137.9	20,000	3.4	15.6
65YLX-6-4C	6	-04	6.4	1/4	9/16 - 18	72	39	19	137.9	20,000	3.4	15.6

Design Factor >2:1

## 6ZELX – Male water jetting nozzle

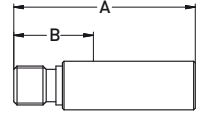

**MATERIAL** Special materials, C: Stainless steel

#						A	B			Nipple ID	Ferrule OD
	DN	size	mm	inch				mm	mm		
6ZELX-5-3C	5	-03	4.8	3/16	5/16 - 24 RH	56	28	137.9	20,000	2.1	15.0

## 1Y2LX / 6Y2LX – Medium pressure tube nipple

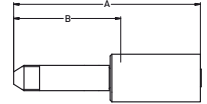

**MATERIAL** Special materials, C: Stainless steel

#						A	B			Nipple ID	Ferrule OD
	DN	size	mm	inch				mm	mm		
1Y2LX-6-025	4	-025	4.0	5/32	3/8 - 24UNF-LH	112	65	137.9	20,000	1.4	14.6
1Y2LX-6-03	5	-03	4.8	3/16	3/8 - 24UNF-LH	118	65	137.9	20,000	1.4	15.3
1Y2LX-6-04	6	-04	6.4	1/4	3/8 - 24UNF-LH	120	65	137.9	20,000	2.9	17.0
1Y2LX-3-04C	6	-04	6.4	1/4	3/8 - 24UNF-LH	109	65	137.9	20,000	2.9	17.0
1Y2LX-9-05	8	-05	7.9	5/16	9/16 - 18 UNF LH	105	60	137.9	20,000	3.7	21.0
1Y2LX-9-06C	10	-06	9.5	3/8	9/16 - 18 UNF LH	137	91	137.9	20,000	5.8	26.9
1Y2LX-9-08	12	-08	12.7	1/2	9/16 - 18 UNF LH	110	60	137.9	20,000	6.7	30.7
1Y2LX-12-08C	12	-08	12.7	1/2	3/4 - 16 UNF LH	158	104	137.9	20,000	6.7	30.7
1Y2LX-12-12C4462	20	-12	19.0	3/4	3/4 - 16 UNF LH	160	100	137.9	20,000	12.7	38.5
6Y2LX-16-12C	20	-12	19.0	3/4	1 - 14 UNS-LH	137	70	137.9	20,000	13.3	34.2

Hoses with design factor >2:1

## 2448D-Tough Cover

# 2448D-TOUGH COVER – Ultra-high pressure hose

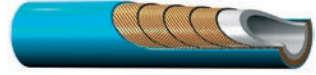







**CONSTRUCTION**

**Core tube** : Polyoxymethylene  
**Pressure reinforcement** : Four spiral layers of maximum tensile steel wire

**Cover** : Polyamide  
**Standard colour** : blue

**TEMPERATURE RANGE** -10°C up to +70°C

#											
	DN	size	mm	inch	mm	MPa	psi	MPa	psi	mm	kg/m
2448D-025V32-TC	4	-025	4.0	5/32	9.9	325	47,120	650	94,240	100	0.21

NOTES -



### 6YHLX – UNF male nozzle nipple

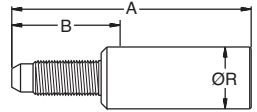

**MATERIAL** Stainless steel

**NOTE** \*ProLance fitting

#						A	B	R			Nipple ID	Ferrule OD
	DN	size	mm	inch					MPa	psi		
6YHLX-4-2AC-PL*	4	-025	4.0	5/32	1/4 - 28 UNF	58	26	8	280	40,600	1.6	11.6
6YHLX-4-2AC-PL-LH*	4	-025	4.0	5/32	1/4 - 28 UNF LH	58	26	8	280	40,600	1.6	11.6

### 6HYLX – UNF female for water jetting nozzle

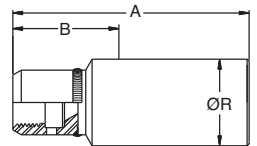

**MATERIAL** Stainless steel

**NOTE** \*ProLance fitting

#						A	B	R			Nipple ID	Ferrule OD
	DN	size	mm	inch					MPa	psi		
6HYLX-4-2AC-PL*	4	-025	4.0	5/32	1/4 - 28 UNF	51	19	9	280	40,600	1.6	11.6
6HYLX-4-2AC-PL-LH*	4	-025	4.0	5/32	1/4 - 28 UNF LH	51	19	9	280	40,600	1.6	11.6
6HYLX-6-2AC-PL-LH*	4	-025	4.0	5/32	3/8 - 24 UNF-LH	49	21	11	280	40,600	1.6	11.6

Design Factor >2:1

Hoses with design factor >2:1

6Y4LX – 6AYLX

## 6Y4LX – High pressure tube nipple UNF – LH thread

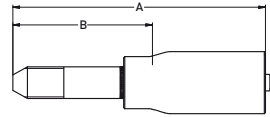

**MATERIAL** Stainless steel

#	⊙				⌚	A	B	↻		Nipple ID	Ferrule OD
	DN	size	mm	inch				MPa	psi		
6Y4LX-4-2AC	4	-025	4.0	5/32	1/4 - 28UNF-LH	75	44	400	58,000	1.6	13.2
6Y4LX-6-2AC	4	-025	4.0	5/32	3/8 - 24UNF-LH	86	55	400	58,000	1.6	13.2

## 6AYLX – Type “M” female swivel

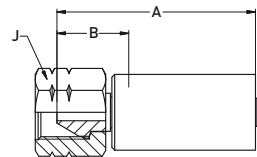

**MATERIAL** Stainless steel

#	⊙				⌚	A	B	J	↻		Nipple ID	Ferrule OD
	DN	size	mm	inch					MPa	psi		
6AYLX-6-2AC	4	-025	4.0	5/32	9/16 - 18 UNF	64	33	17	301	43,645	1.6	13.2

Design Factor >2:1

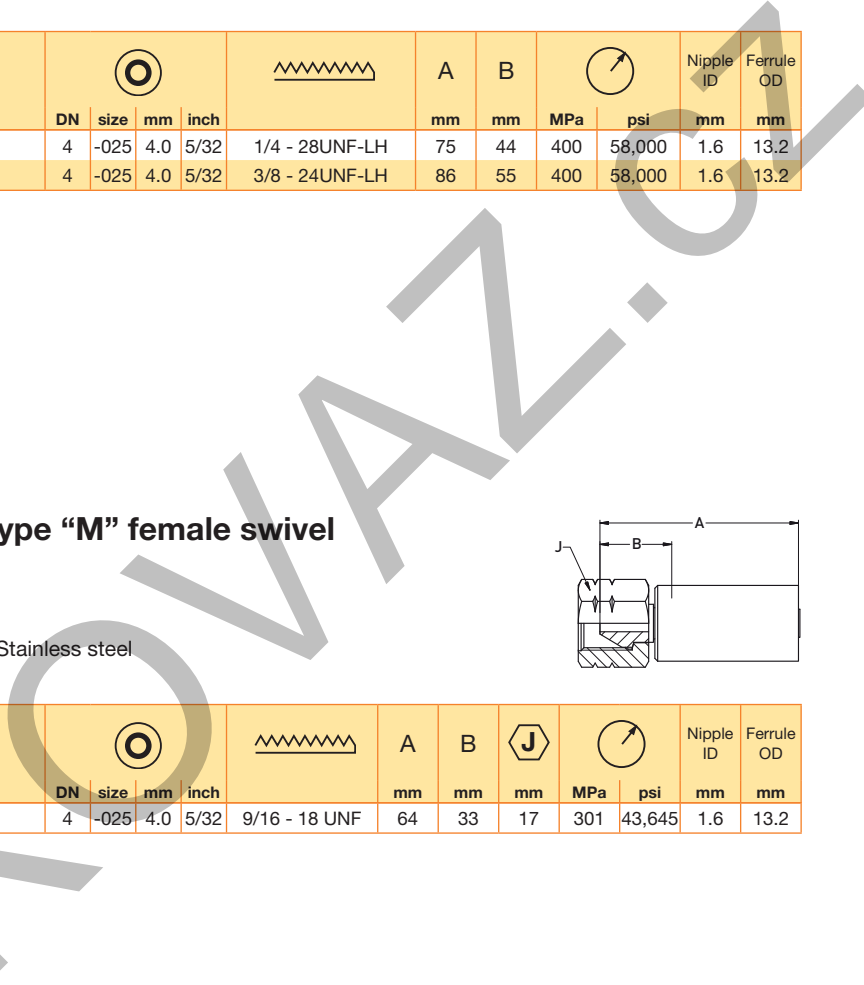



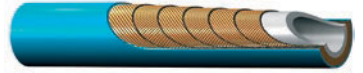



## 2640D / 2640N – Ultra-high pressure hose



**CONSTRUCTION**

- Core tube** : DN 4-8: Polyoxymethylene; DN 12-25: Polyamide
- Pressure reinforcement** : Six spiral layers of maximum tensile steel wire
- Cover** : Polyamide
- Standard colour** : Blue

**TEMPERATURE RANGE** -10°C up to +70°C

#													
	DN	size	mm	inch	mm	MPa	psi	MPa	psi	mm	kg/m		
2640D-025V32	4	-025	3.9	5/32	12.0	280	40,600	700	101,500	140	0.29		
2640D-03V32	5	-03	4.8	3/16	13.0	250	36,250	625	90,625	175	0.41		
2640D-04V32	6	-04	6.4	1/4	14.6	250	36,250	625	90,625	200	0.64		
2640D-05V32	8	-05	8.0	5/16	16.9	210	30,450	525	76,125	225	0.68		
2640N-08V32	12	-08	12.8	1/2	24.5	180	26,100	450	65,250	290	1.36		
2640N-12V32	20	-12	19.6	3/4	33.0	140	20,300	350	50,750	350	2.10		
2640N-16V32	25	-16	25.0	1	40.0	120	17,400	300	43,500	400	2.90		

NOTES -

Hoses with design factor >2:1

1Y42X – 1YM2X / 1YMJX

## 1Y42X – High pressure tube nipple UNF – LH thread

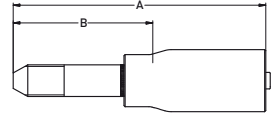

**MATERIAL** Nipple: very high strength stainless steel  
Shell: high strength carbon steel, zinc plated

#	⊙				📏	A	B	↗		Nipple ID	Ferrule OD
	DN	size	mm	inch				MPa	psi		
1Y42X-4-025	4	-025	4.0	5/32	1/4 - 28UNF-LH	88	45	400	58,000	1.9	15.6
1Y42X-6-025	4	-025	4.0	5/32	3/8 - 24UNF-LH	98	55	400	58,000	1.9	15.6
1Y42X-4-03	5	-03	4.8	3/16	1/4 - 28UNF-LH	116	63	400	58,000	2.3	18.6
1Y42X-6-03	5	-03	4.8	3/16	3/8 - 24UNF-LH	116	63	400	58,000	2.3	18.6
1Y42X-9-03	5	-03	4.8	3/16	9/16 - 18UNF-LH	116	63	400	58,000	2.3	18.6
1Y42X-6-04	6	-04	6.4	1/4	3/8 - 24UNF-LH	116	63	400	58,000	3.1	19.1
1Y42X-9-04	6	-04	6.4	1/4	9/16 - 18UNF-LH	116	63	400	58,000	3.1	19.1
1Y42X-6-05	8	-05	7.9	5/16	3/8 - 24UNF-LH	116	63	400	58,000	3.7	22.0
1Y42X-9-05	8	-05	7.9	5/16	9/16 - 18UNF-LH	125	72	400	58,000	3.7	22.0

## 1YM2X / 1YMJX – High pressure tube nipple metric – LH thread

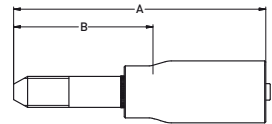

**MATERIAL** Nipple: very high strength stainless steel  
Shell: high strength carbon steel, zinc plated

#	⊙				📏	A	B	↗		Nipple ID	Ferrule OD
	DN	size	mm	inch				MPa	psi		
1YM2X-6-025	4	-025	4.0	5/32	M14x1.5-LH	108	55	400	58,000	1.9	15.6
1YM2X-6-03	5	-03	4.8	3/16	M14x1.5-LH	116	63	400	58,000	2.3	18.6
1YM2X-6-04	6	-04	6.4	1/4	M14x1.5-LH	116	63	400	58,000	3.1	19.1
1YM2X-6-05	8	-05	7.9	5/16	M14x1.5-LH	125	72	400	58,000	3.7	22.0
1YMJX-11-08W	12	-08	12.7	1/2	M18x1.5-LH	141	87	250	36,250	6.8	34.0
1YMJX-12-08W	12	-08	12.7	1/2	M20x1.5-LH	141	87	300	43,500	6.8	34.0

Design Factor >2:1

### 1AY2X / 1AYJX – Type “M” female swivel

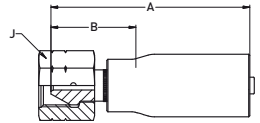

**MATERIAL** Nipple: very high strength stainless steel  
 Shell and nut: high strength carbon steel, zinc plated

#						A	B				Nipple ID	Ferrule OD
	DN	size	mm	inch					MPa	psi		
1AY2X-6-025	4	-025	4.0	5/32	9/16 - 18UNF	61	24	22	400	58,000	1.9	15.6
1AY2X-6-03	5	-03	4.8	3/16	9/16 - 18UNF	91	38	22	400	58,000	2.3	18.6
1AY2X-8-05	8	-05	7.9	5/16	3/4 - 16UNF	91	38	27	320	46,400	3.7	22.0
1AY2X-10-05	8	-05	7.9	5/16	7/8 - 14UNF	91	38	30	320	46,400	3.7	22.0
1AY2X-13-05	8	-05	7.9	5/16	1 1/8 - 11UNF	91	38	36	320	46,400	3.7	22.0
1AYJX-11-08W	12	-08	12.7	1/2	1 - 12UNF	86	29	32	180	26,100	6.8	34.0
1AYJX-16-12W	20	-12	19.0	3/4	1 5/16-12UNF	90	31	41	160	23,200	12.5	40.6

Design Factor >2:1

### 1C92X / 1C9JX – Metric female swivel heavy series with O-ring

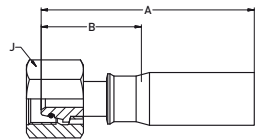

**MATERIAL** Nipple: very high strength stainless steel  
 Shell and nut: high strength carbon steel, zinc plated

#						A	B				Nipple ID	Ferrule OD
	DN	size	mm	inch					MPa	psi		
1C92X-12-05	8	-05	7.9	5/16	M20x1.5	91	38	27	280	40,600	3.7	22.0
1C9JX-16-08W	12	-08	12.7	1/2	M24x1.5	96	39	32	180	26,100	6.8	34.0
1C9JX-25-12W	20	-12	19.0	3/4	M36x2	108	49	46	160	23,200	12.5	40.6
1C9JX-30-16W	25	-16	25.4	1	M42x2	121	55	55	150	21,750	17.3	49.0

## 1922X – BSP female swivel (60° cone)

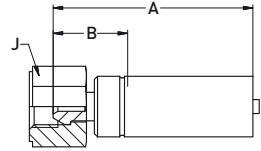

**MATERIAL** Nipple: very high strength carbon steel, zinc plated  
 Shell and nut: high strength carbon steel, zinc plated

#	⊙				⌚	A	B	J	↻		Nipple ID	Ferrule OD
	DN	size	mm	inch					MPa	psi		
1922X-4-025	4	-025	4.0	5/32	G 1/4	70	26	22	300	43500	1.9	15.6
1922X-4-03	5	-03	4.8	3/16	G 1/4	79	26	22	300	43500	2.3	18.6

## 16Y2X – High pressure female swivel

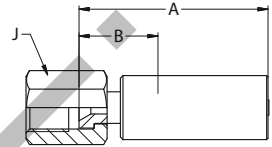

**MATERIAL** Nipple: very high strength stainless steel  
 Shell and nut: high strength carbon steel, zinc plated

#	⊙				⌚	A	B	J	↻		Nipple ID	Ferrule OD
	DN	size	mm	inch					MPa	psi		
16Y2X-4-025	4	-025	4	5/32	9/16 - 18UNF	76	23	19	300	43,500	1.9	15.6
16Y2X-4-03	5	-03	4.8	3/16	9/16 - 18UNF	76	23	19	300	43,500	2.3	18.6

## 6Y25X / 1Y2JX – Medium pressure tube nipple

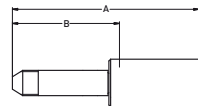

**MATERIAL** Nipple: very high strength stainless steel  
 Shell: stainless steel

#	⊙				⌚	A	B	↻		Nipple ID	Ferrule OD
	DN	size	mm	inch				MPa	psi		
6Y25X-9-8C	12	-08	12.7	1/2	9/16 - 18 LH	107	53	137.9	20,000	8.1	31.0
6Y25X-12-8C	12	-08	12.7	1/2	3/4 - 16 LH	107	53	137.9	20,000	8.1	31.0
1Y2JX-16-12W	20	-12	19.0	3/4	1 - 14 UNF-LH	133	70	137.9	20,000	12.5	40.6
1Y2JX-16-16W	25	-16	25.4	1	1 - 14 UNF-LH	146	70	137.9	20,000	17.3	49.0

Design Factor >2:1

### 1MR2X – Metric female swivel 59° cone

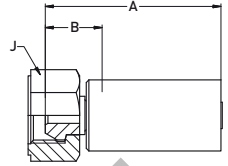

**MATERIAL** High strength carbon steel, zinc plated

#						A	B				Nipple ID	Ferrule OD
	DN	size	mm	inch					MPa	psi		
1MR2X-8-03	5	-03	4.8	3/16	M14x1.5	91	38	22	400	58,000	2.3	18.6
1MR2X-10-03	5	-03	4.8	3/16	M16x1.5	91	38	22	400	58,000	2.3	18.6
1MR2X-12-03	5	-03	4.8	3/16	M18x1.5	91	38	24	400	58,000	2.3	18.6

### 1TM2X – Polyflex Lok components



#	Description
1TM2X-8-05-HPK	Fitting for DN8 hoses incl. caps (refer to pages D-2, D-3)
1TM2X-8-03-HPK	Fitting for DN5 hoses incl. caps (refer to pages D-2, D-3)

Design Factor >2:1

Hoses with design factor >2:1

1C35X – 1C95X – 1AY5X

## 1C35X – Metric female swivel light series

**For hydraulic oil only**

**MATERIAL** Nipple: very high strength carbon steel, zinc plated  
Shell and nut: high strength carbon steel, zinc plated

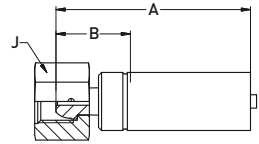

#	⊙				▄▄▄▄▄▄	A	B	J	↗		Nipple ID	Ferrule OD
	DN	size	mm	inch					MPa	psi		
1C35X-8-03	5	-03	4.8	3/16	M14x1.5	64	25	22	250	36,250	1.7	19.1

## 1C95X – Metric female swivel heavy series with O-ring

**For hydraulic oil only**

**MATERIAL** Nipple: very high strength carbon steel, zinc plated  
Shell and nut: high strength carbon steel, zinc plated

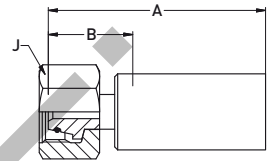

#	⊙				▄▄▄▄▄▄	A	B	J	↗		Nipple ID	Ferrule OD
	DN	size	mm	inch					MPa	psi		
1C95X-16-08	12	-08	12.7	1/2	M24x1.5	87	34	32	180	26,100	6.7	34.1
1C95X-25-12	20	-12	19.0	3/4	M36x2	92	39	46	140	20,300	12.7	41.8

## 1AY5X – Type “M” female swivel

**For hydraulic oil only**

**MATERIAL** Nipple: very high strength carbon steel, zinc plated  
Shell and nut: high strength carbon steel, zinc plated

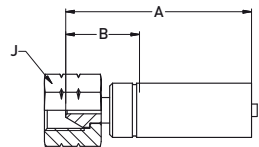

#	⊙				▄▄▄▄▄▄	A	B	J	↗		Nipple ID	Ferrule OD
	DN	size	mm	inch					MPa	psi		
1AY5X-6-03	5	-03	4.8	3/16	9/16 - 18UNF	66	26	22	250	36,250	1.7	19.1
1AY5X-11-08	12	-08	12.7	1/2	1 - 12 UNF	80	27	32	180	26,100	6.7	34.1
1AY5X-16-12	20	-12	19.0	3/4	1 5/16 - 12UNF	82	29	41	140	20,300	12.7	41.8

Design Factor >2:1



**1YA5X – High pressure tube nipple  
 UNF – LH thread**

*For hydraulic oil only*

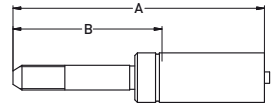

**MATERIAL** Special materials

#						A	B			Nipple ID	Ferrule OD
	DN	size	mm	inch				MPa	psi		
1YA5X-1-03	5	-03	4.8	3/16	1/4 - 28UNF-LH	92	53	250	36,250	1.3	19.1
1YA5X-3-03	5	-03	4.8	3/16	3/8 - 24UNF-LH	97	58	250	36,250	1.3	19.1

Design Factor >2:1

**1925X – BSP female swivel (60° cone)**

*For hydraulic oil only*

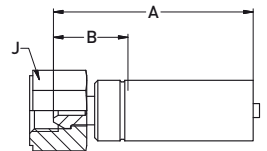

**MATERIAL** Nipple: very high strength carbon steel, zinc plated  
 Shell and nut: high strength carbon steel, zinc plated

#						A	B				Nipple ID	Ferrule OD
	DN	size	mm	inch					MPa	psi		
1925X-4-03	5	-03	4.8	3/16	G 1/4	78	32	22	250	36,250	1.7	19.1



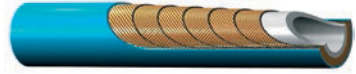



## 2648N – Ultra-high pressure hose



**CONSTRUCTION**

- Core tube : Polyamide
- Pressure reinforcement : Six spiral layers of maximum tensile steel wire
- Cover : Polyamide
- Standard colour : Blue

**TEMPERATURE RANGE** -10°C up to +70°C



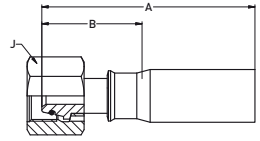

#													
	DN	size	mm	inch	mm	MPa	psi	MPa	psi	mm	kg/m		
2648N-12V32	20	-12	19.8	3/4	33.7	160	23,200	400	58,000	350	2.28		
2648N-16V32	25	-16	25.0	1	40.8	150	21,750	375	54,375	400	3.10		

NOTES -

**1C9JX / 1C9CX – Metric female swivel heavy series with O-ring**





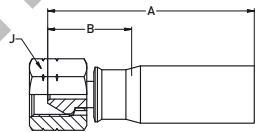

**MATERIAL** Nipple: very high strength stainless steel  
 Shell and nut: high strength carbon steel, zinc plated

#						A	B				Nipple ID	Ferrule OD
	DN	size	mm	inch					MPa	psi		
1C9JX-25-12W	20	-12	19.0	3/4	M36x2	108	50	46	160	23,200	12.5	40.6
1C9CX-30-16W	25	-16	25.4	1	M42x2	121	55	55	150	21,750	17.3	49.0

**1AYJX / 1AYCX – Type “M” female swivel**





**MATERIAL** Nipple: very high strength stainless steel  
 Shell and nut: high strength carbon steel, zinc plated

#						A	B				Nipple ID	Ferrule OD
	DN	size	mm	inch					MPa	psi		
1AYJX-16-12W	20	-12	19.0	3/4	1 5/16-12UNF	90	31	41	160	23,200	12.5	40.6
1AYCX-16-16W	25	-16	25.4	1	1 5/16-12UNF	146	72	41	138	20,000	17.3	49.0

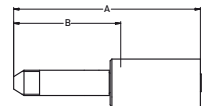
**1Y2CX – Medium pressure tube nipple**



**MATERIAL** Nipple: very high strength stainless steel  
 Shell: high strength carbon steel, zinc plated

#						A	B			Nipple ID	Ferrule OD
	DN	size	mm	inch				MPa	psi		
1Y2CX-16-16W	25	-16	25.4	1	1-14UNF-LH	146	72	138	20,000	17.3	49

Design Factor >2:1

## 2740D – Ultra-high pressure hose



**CONSTRUCTION**

**Core tube** : Polyoxymethylene  
**Pressure reinforcement** : Six spiral layers of maximum tensile steel wire

**Cover** : DN4: Polyurethane, DN5-12: Polyamide  
**Standard colour** : DN4: yellow, DN5-8: red, DN12: black

**TEMPERATURE RANGE** -10°C up to +70°C

#	Ø				Ø			Ø		Ø		kg/m
	DN	size	mm	inch	mm	MPa	psi	MPa	psi	mm		
2740D-025V16	4	-025	3.9	5/32	12.0	300	43,500	780	113,100	120	0.40	
2740D-03V34	5	-03	4.8	3/16	13.2	280	40,600	700	101,500	200	0.47	
2740D-05V34	8	-05	7.8	5/16	17.2	250	36,250	625	90,625	200	0.83	
2740D-08V30	12	-08	12.7	1/2	27.0	200	29,000	500	72,500	300	1.85	







NOTES -

Design Factor >2:1

**2741D – Ultra-high pressure hose  
with 2nd cover**

<b>CONSTRUCTION</b>	<b>Core tube</b>	: Polyoxymethylene
	<b>Pressure reinforcement</b>	: Six spiral layers of maximum tensile steel wire
	<b>Cover</b>	: 1 <sup>st</sup> : Polyamide; 2 <sup>nd</sup> : Polyurethane, abrasion resistant
	<b>Standard colour</b>	: 1 <sup>st</sup> : Red; 2 <sup>nd</sup> : Black

**TEMPERATURE RANGE** -10°C up to +70°C

#												
	DN	size	mm	inch	mm	MPa	psi	MPa	psi	mm	kg/m	
2741D-05V34/10	8	-05	7.7	5/16	21.2	250	36,250	625	90,625	200	0.95	

NOTES -







## 2748D – Ultra-high pressure hose



**CONSTRUCTION**

- Core tube** : Polyoxymethylene
- Pressure reinforcement** : Six spiral layers of maximum tensile steel wire
- Cover** : Polyamide
- Standard colour** : Red

**TEMPERATURE RANGE** -10°C up to +70°C

#												
	DN	size	mm	inch	mm	MPa	psi	MPa	psi	mm	kg/m	
2748D-05V34	8	-05	7.8	5/16	17.3	280	40,600	700	101,500	230	0.83	

NOTES -







## 2748D – Ultra-high pressure hose with 2nd cover



**CONSTRUCTION**

- Core tube** : Polyoxymethylene
- Pressure reinforcement** : Six spiral layers of maximum tensile steel wire
- Cover** : 1<sup>st</sup>: Polyamide; 2<sup>nd</sup>: Polyurethane, abrasion resistant
- Standard colour** : 1<sup>st</sup>: Red; 2<sup>nd</sup>: Yellow

**TEMPERATURE RANGE** -10°C up to +70°C

#												
	DN	size	mm	inch	mm	MPa	psi	MPa	psi	mm	kg/m	
2748D-05V34/16	8	-05	7.8	5/16	21.8	280	40,600	700	101,500	230	0.99	

NOTES -

Design Factor >2:1







## 2749D – Ultra-high pressure hose



**CONSTRUCTION**

- Core tube** : Polyoxymethylene
- Pressure reinforcement** : Six spiral layers of maximum tensile steel wire
- Cover** : Polyamide
- Standard colour** : Red

**TEMPERATURE RANGE** -10°C up to +70°C

#													
	DN	size	mm	inch	mm	MPa	psi	MPa	psi	mm	kg/m		
2749D-03V34	5	-03	4.8	3/16	13.3	301	43,645	700	101,500	200	0.47		
2749D-05V34	8	-05	7.8	5/16	17.3	301	43,645	700	101,500	230	0.83		



NOTES -

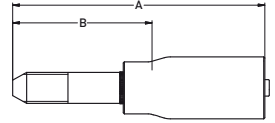

### 1YM2X / 6YMHX – High pressure tube nipple metric – LH thread





**MATERIAL** Nipple: very high strength stainless steel  
 Shell: high strength carbon steel, zinc plated

#						A	B			Nipple ID	Ferrule OD
	DN	size	mm	inch				MPa	psi		
1YM2X-6-025	4	-025	4.0	5/32	M14x1.5-LH	108	55	400	58,000	1.9	15.6
1YM2X-6-03	5	-03	4.8	3/16	M14x1.5-LH	116	63	400	58,000	2.3	18.6
1YM2X-6-05	8	-05	7.9	5/16	M14x1.5-LH	125	72	400	58,000	3.7	22.8
6YMHX-11-8C	12	-08	12.7	1/2	M18x1.5-LH	138	80	250	36,250	7.5	31.9
6YMHX-12-8C	12	-08	12.7	1/2	M20x1.5-LH	138	80	300	43,500	7.5	31.9

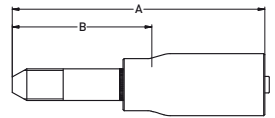
### 1Y42X / 6Y4HX – High pressure tube nipple UNF – LH thread



**MATERIAL** Nipple: very high strength stainless steel  
 Shell: high strength carbon steel, zinc plated

#						A	B			Nipple ID	Ferrule OD
	DN	size	mm	inch				MPa	psi		
1Y42X-4-025	4	-025	4.0	5/32	1/4 - 28UNF-LH	88	45	400	58,000	1.9	15.6
1Y42X-6-025	4	-025	4.0	5/32	3/8 - 24UNF-LH	98	55	400	58,000	1.9	15.6
1Y42X-4-03	5	-03	4.8	3/16	1/4 - 28UNF-LH	116	63	400	58,000	2.3	18.6
1Y42X-6-03	5	-03	4.8	3/16	3/8 - 24UNF-LH	116	63	400	58,000	2.3	18.6
1Y42X-9-03	5	-03	4.8	3/16	9/16 - 18UNF-LH	116	63	400	58,000	2.3	18.6
1Y42X-6-05	8	-05	7.9	5/16	3/8 - 24UNF-LH	116	63	400	58,000	3.7	22.8
1Y42X-9-05	8	-05	7.9	5/16	9/16 - 18UNF-LH	125	72	400	58,000	3.7	22.8
6Y4HX-16-8C	12	-08	12.7	1/2	1 - 14UNF-LH	138	80	300	43500	7.5	31.9

Design Factor >2:1

Hoses with design factor >2:1

**1AY2X – 16Y2X**

**1AY2X – Type “M” female swivel**

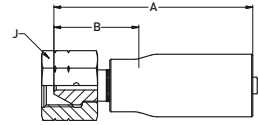

**MATERIAL** Nipple: very high strength stainless steel  
Shell and nut: high strength carbon steel, zinc plated

#	⊙				⋈	A	B	J	↻		Nipple ID	Ferrule OD
	DN	size	mm	inch					MPa	psi		
1AY2X-6-025	4	-025	4.0	5/32	9/16 - 18UNF	61	24	22	400	58,000	1.9	15.6
1AY2X-6-03	5	-03	4.8	3/16	9/16 - 18UNF	91	38	22	400	58,000	2.3	18.6
1AY2X-8-05	8	-05	7.9	5/16	3/4 - 16UNF	91	38	27	320	46,400	3.7	22.8
1AY2X-10-05	8	-05	7.9	5/16	7/8 - 14UNF	91	38	30	320	46,400	3.7	22.8
1AY2X-13-05	8	-05	7.9	5/16	1 1/8 - 11UNF	91	38	36	320	46,400	3.7	22.8

**16Y2X – High pressure female swivel**

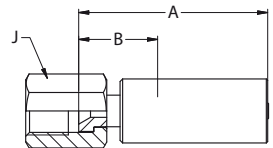

**MATERIAL** Nipple: very high strength stainless steel  
Shell and nut: high strength carbon steel, zinc plated

#	⊙				⋈	A	B	J	↻		Nipple ID	Ferrule OD
	DN	size	mm	inch					MPa	psi		
16Y2X-4-025	4	-25	4	5/32	9/16 - 18	76	23	19	300	43,500	1.9	15.6
16Y2X-4-03	5	-03	4.8	3/16	9/16 - 18	76	23	19	300	43,500	2.3	18.6

Design Factor >2:1

### 1922X – BSP female swivel (60° cone)

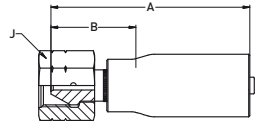

**MATERIAL** Nipple: very high strength stainless steel  
 Shell and nut: high strength carbon steel, zinc plated

#						A	B				Nipple ID	Ferrule OD
	DN	size	mm	inch					MPa	psi		
1922X-4-025	4	-025	4.0	5/32	G 1/4	70	26	22	300	43,500	1.9	15.6
1922X-4-03	5	-03	4.8	3/16	G 1/4	79	26	22	300	43,500	2.3	18.6

Design Factor >2:1

### 6Y4HX – High pressure tube nipple UNF – LH thread

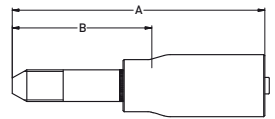

**MATERIAL** Nipple: very high strength stainless steel  
 Shell: high strength carbon steel, zinc plated

#						A	B			Nipple ID	Ferrule OD
	DN	size	mm	inch				MPa	psi		
6Y4HX-16-8C	12	-08	12.7	1/2	1 - 14 UNS-LH	138	80	300	43500	7.5	31.9

Hoses with design factor >2:1

**1C92X – 1TM2X**

**1C92X – Metric female swivel  
heavy series with O-ring**

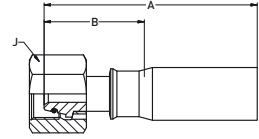

**MATERIAL** Nipple: very high strength stainless steel  
Shell and nut: high strength carbon steel, zinc plated

#	⊙				⌚	A	B	J	↗		Nipple ID	Ferrule OD
	DN	size	mm	inch					MPa	psi		
1C92X-12-05	8	-05	7.9	5/16	M20x1.5	91	38	27	280	40,600	3.7	22.0

**1TM2X – Polyflex Lok components**



#	Description
1TM2X-8-05-HPK	Fitting for DN8 hoses incl. caps (refer to pages D-2, D-3)
1TM2X-8-03-HPK	Fitting for DN5 hoses incl. caps (refer to pages D-2, D-3)

Design Factor >2:1

## 2840D – Ultra-high pressure hose



**CONSTRUCTION**

**Core tube** : Polyoxymethylene  
**Pressure reinforcement** : Eight spiral layers of maximum tensile steel wire  
**Cover** : Polyamide  
**Standard colour** : DN5: red, DN8: yellow, DN12: black

**TEMPERATURE RANGE**

-10°C up to +70°C

Design Factor >2:1

#	Ø				Ø			⌘		⌘		kg/m
	DN	size	mm	inch	mm	MPa	psi	MPa	psi	mm		
2840D-03V34	5	-03	4.6	3/16	15.0	400	58,000	800	116,000	200	0.66	
2840D-05V36	8	-05	7.8	5/16	19.5	300	43,500	700	101,500	250	1.10	
2840D-08V30	12	-08	12.7	1/2	29.8	250	36,250	625	90,625	350	2.50	

**NOTES**

The design factor of burst pressure over working pressure can be adjusted to the specific application but must not be reduced below a ratio of 1:2.

Hoses with design factor >2:1

2841D

## 2841D – Ultra-high pressure hose









### CONSTRUCTION

**Core tube** : Polyoxymethylene  
**Pressure reinforcement** : Eight spiral layers of maximum tensile steel wire  
**Cover** : 1<sup>st</sup>: Polyamide; 2<sup>nd</sup>: Polyurethane, abrasion resistant  
**Standard colour** : 1<sup>st</sup>: Yellow; 2<sup>nd</sup>: Grey

### TEMPERATURE RANGE

-10°C up to +70°C

#												
	DN	size	mm	inch	mm	MPa	psi	MPa	psi	mm	kg/m	
2841D-05V36/17	8	-05	7.7	5/16	23.5	300	43,500	700	101,500	250	1.38	

NOTES -

## 2848D – Ultra-high pressure hose



**CONSTRUCTION**

- Core tube** : Polyoxymethylene
- Pressure reinforcement** : Eight spiral layers of maximum tensile steel wire
- Cover** : Polyamide
- Standard colour** : DN8: Red; DN12: Black

**TEMPERATURE RANGE** -10°C up to +70°C

#	Ø				Ø			⌘		⌘		kg/m
	DN	size	mm	inch	mm	MPa	psi	MPa	psi	mm		
2848D-05V34	8	-05	7.8	5/16	19.6	320	46,400	800	116,000	280	1.10	
2848D-08V30	12	-08	13.0	1/2	29.9	300	43,500	625	90,625	350	2.5	

NOTES -

Design Factor >2:1

Hoses with design factor >2:1  
 1YM2X / 6YMWX – 1Y42X / 6Y4WX

## 1YM2X / 6YMWX – High pressure tube nipple metric – LH thread

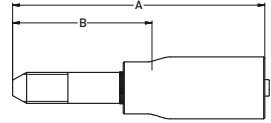

**MATERIAL** Nipple: very high strength stainless steel  
 Shell: high strength carbon steel, zinc plated

#	⊙				🌀	A	B	↻		Nipple ID	Ferrule OD
	DN	size	mm	inch				MPa	psi		
1YM2X-6-03	5	-03	4.8	3/16	M14x1.5-LH	116	63	400	58,000	2.3	19.6
1YM2X-6-05	8	-05	7.9	5/16	M14x1.5-LH	125	72	400	58,000	3.7	24.0
6YMWX-11-8C	12	-08	12.8	1/2	M18x1.5-LH	138	80	250	36250	7.5	33.8
6YMWX-12-8C	12	-08	12.8	1/2	M20x1.5-LH	138	80	300	43500	7.5	33.8

## 1Y42X / 6Y4WX – High pressure tube nipple metric – UNF thread

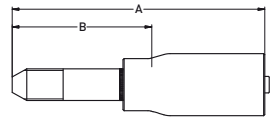

**MATERIAL** Nipple: very high strength stainless steel  
 Shell: high strength carbon steel, zinc plated

#	⊙				🌀	A	B	↻		Nipple ID	Ferrule OD
	DN	size	mm	inch				MPa	psi		
1Y42X-6-03	5	-03	4.8	3/16	3/8 - 24UNF-LH	116	63	400	58,000	2.3	19.6
1Y42X-9-03	5	-03	4.8	3/16	9/16 - 18UNF-LH	116	63	400	58,000	2.3	19.6
1Y42X-6-05	8	-05	7.9	5/16	3/8 - 24UNF-LH	116	63	400	58,000	3.7	24.0
1Y42X-9-05	8	-05	7.9	5/16	9/16 - 18UNF-LH	125	72	400	58,000	3.7	24.0
6Y4WX-16-8C	12	-08	12.7	1/2	1 - 14UNF-LH	138	80	300	43,500	7.6	34.2

Design Factor >2:1



## 1AY2X – Type “M” female swivel

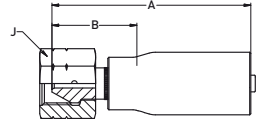

**MATERIAL** Nipple: very high strength stainless steel  
Shell and nut: high strength carbon steel, zinc plated

#	⊙				⋄	A	B	J	↗		Nipple ID	Ferrule OD
	DN	size	mm	inch					MPa	psi		
1AY2X-6-03	5	-03	4.8	3/16	9/16 - 18UNF	91	38	22	400	58,000	2.3	19.6
1AY2X-8-05	8	-05	7.9	5/16	3/4 - 16UNF	91	38	27	320	46,400	3.7	24.0
1AY2X-10-05	8	-05	7.9	5/16	7/8 - 14UNF	91	38	30	320	46,400	3.7	24.0
1AY2X-13-05	8	-05	7.9	5/16	1 1/8 - 11UNF	91	38	36	320	46,400	3.6	24.0

## 1TM2X – Polyflex Lok components



#	Description
1TM2X-8-05-HPK	Fitting for DN8 hoses incl. caps (refer to pages D-2, D-3)
1TM2X-8-03-HPK	Fitting for DN5 hoses incl. caps (refer to pages D-2, D-3)







## 2849D – Ultra-high pressure hose



**CONSTRUCTION**

- Core tube** : Polyoxymethylene
- Pressure reinforcement** : Eight spiral layers of maximum tensile steel wire
- Cover** : Polyamide
- Standard colour** : Red

**TEMPERATURE RANGE** -10°C up to +70°C

#													
	DN	size	mm	inch	mm	MPa	psi	MPa	psi	mm	kg/m		
2849D-05V34	8	-05	7.8	5/16	19.6	380	55,000	800	116,000	280	1.10		



NOTES -

Design Factor >2:1

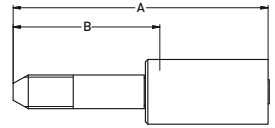
KONVINC



**6YMWX – High pressure tube nipple  
metric – LH thread**

**MATERIAL** Nipple: very high strength stainless steel  
Shell: high strength carbon steel, zinc plated

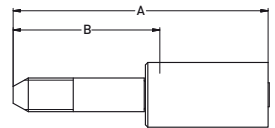
#						A	B			Nipple ID	Ferrule OD
	DN	size	mm	inch				MPa	psi		
6YMWX-6-5C-55	8	-05	7.9	5/16	M14x1.5-LH	120	65	400	58,000	3.6	24.0

**6Y4WX – High pressure tube nipple  
UNF – LH thread**

**MATERIAL** Nipple: very high strength stainless steel  
Shell: high strength carbon steel, zinc plated

#						A	B			Nipple ID	Ferrule OD
	DN	size	mm	inch				MPa	psi		
6Y4WX-9-5C-55	8	-05	7.9	5/16	9/16 - 18 UNF-LH	120	65	400	58,000	3.6	24.0

Hoses with design factor >2:1



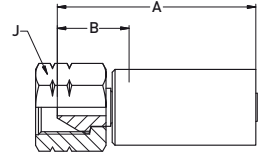

6AYWX

## 6AYWX – Type “M” female swivel



**MATERIAL** Nipple: very high strength stainless steel

Shell and nut: high strength carbon steel, zinc plated

#						A	B				Nipple ID	Ferrule OD
	DN	size	mm	inch					MPa	psi		
6AYWX-10-5C-55	8	-05	7.9	5/16	7/8 - 14UNF	113	45	32	380	55,000	3.6	24.0

Design Factor >2:1

KOLVANZ

---

**Chapter D****Polyflex-Lok**

Polyflex-Lok components ..... D-2

KOVANZ.CZ

## Polyflex-Lok components

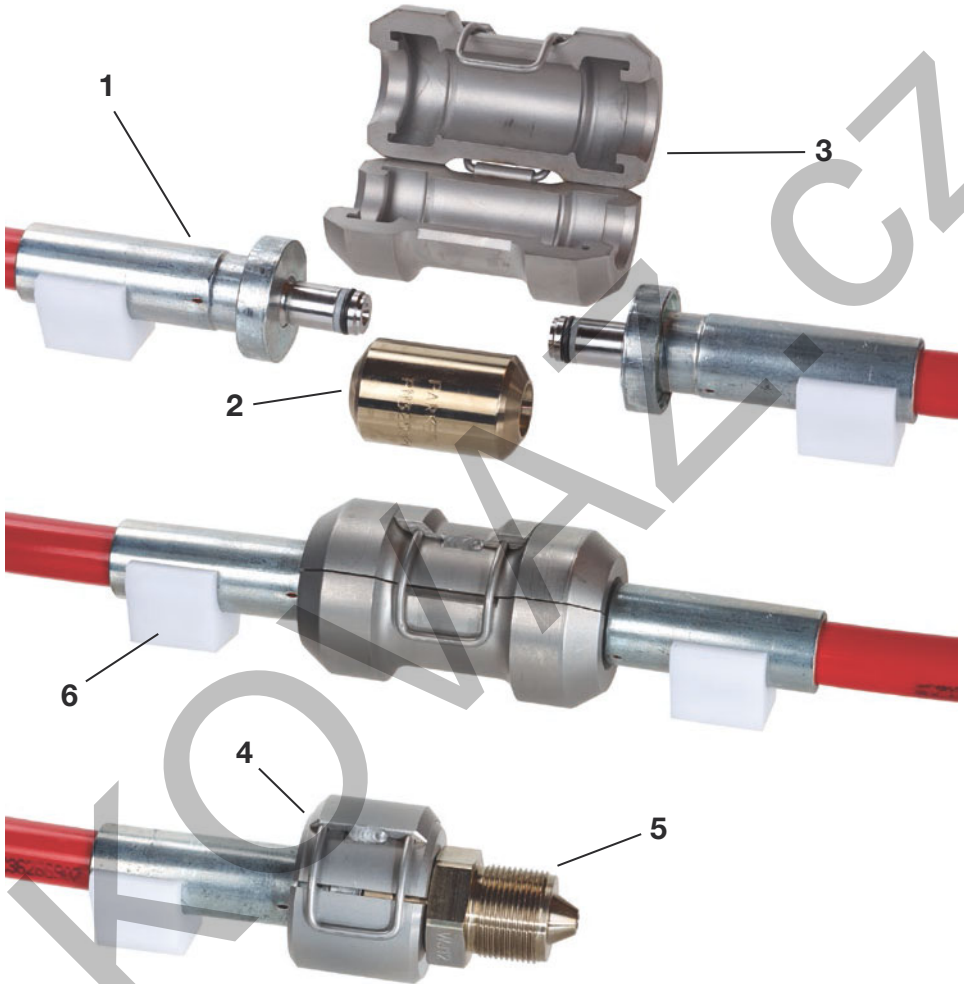

Ref	Part Number	Description
1	<b>1TM2X-8-03-HPK</b>	Fitting for DN 5 hoses incl. caps
	<b>1TM2X-8-05-HPK</b>	Fitting for DN 8 hoses incl. caps
	<b>1TMKY-8-05-HPK</b>	Fitting for DN 8 hoses incl. caps
	<b>1TMBL-9-08-HPK</b>	Fitting for DN 12 hoses incl. caps
	<b>1TMBS-9-08-HPK</b>	Fitting for DN 12 hoses incl. caps
2	<b>TFTF-8-8</b>	Hose connector bushing for DN 5 and DN 8
	<b>TFTF-8-9</b>	Hose connector bushing - connection DN 5 or DN 8 to DN 12
	<b>TFTF-9-9</b>	Hose connector bushing for DN 12
3	<b>HPK-HS-8</b>	Hose connector
4	<b>HPK-HSP-8</b>	Pump/gun connector
5	<b>YTTF-6-8</b>	Adapter M20 x 1.5 to DN 5 or DN 8
	<b>YTTF-9-8</b>	Adapter M26 x 1.5 to DN 5 or DN 8
	<b>YTTF-9-9</b>	Adapter M26 x 1.5 to DN 12
	<b>YTTF-10-8</b>	Adapter M30 x 2 to DN 5 or DN 8
	<b>YTTF-10-9</b>	Adapter M30 x 2 to DN 12
	<b>YTTF-12-8</b>	Adapter M42 x 2 to DN 5 or DN 8
	<b>YTTF-12-9</b>	Adapter M42 x 2 to DN 12
	<b>Y6TF-6-8</b>	Adapter 3/4 - 16UNF to DN 5 or DN 8
	<b>Y6TF-9-8</b>	Adapter 1 1/8 - 12UNF to DN 5 or DN 8
6	<b>TMCAP-8</b>	Cap DN 5 or DN 8
	<b>TMCAP-9</b>	Cap DN 12





**Chapter E****Connectors & Adapters – Valves****High Pressure Connectors & Adapters****Type M**

YAYA.....	E-5
YAY6.....	E-5
Plugs and Caps.....	E-6
Torpedos.....	E-7
YAY5.....	E-7
YA02.....	E-8
YA01.....	E-9

**20,000 PSI – Medium Pressure**

5YY5.....	E-11
5YY6.....	E-12
6YY5.....	E-13
5Y01.....	E-14
02Y5.....	E-15
5Y5Y.....	E-16
5Y6Y.....	E-17
5Y02.....	E-18
Y5Y5.....	E-19
Y5Y6.....	E-20
Y501.....	E-21
L5Y.....	E-22
T5Y.....	E-22
X5Y.....	E-23
Y2N.....	E-23
Y2C.....	E-24
HBPLM Plugs.....	E-24
Y204, Y206, Y209, Y212, and Y216 Nipples.....	E-25

**30,000/60,000 psi – High Pressure**

6YY6 .....	E-27
6Y01 .....	E-28
02Y6 .....	E-29
Y6Y6 .....	E-30
Y601 .....	E-30
6Y6Y .....	E-31
6Y02 .....	E-32
L6Y .....	E-33
T6Y .....	E-33
X6Y .....	E-34
Y4N .....	E-34
Y4C .....	E-34
HBPHM Plug .....	E-35
Locking Nut and Collar .....	E-35
Nipples .....	E-35

**National Pipe Tapered (NPT)**

K0202 – Couplers .....	E-37
KL02 – Elbows .....	E-37
KX02 – Crosses .....	E-38
KT02 – Tees .....	E-38
K0101 – Nipples .....	E-39
K0201 – Reducer bushings .....	E-39

**Valves****Medium Pressure (20,000 psi)**

SV5Y .....	E-41
AV5Y.....	E-42
TV25Y.....	E-43
TV15Y.....	E-44
CV5Y .....	E-45

**High Pressure (30,000 psi)**

SV6Y .....	E-46
AV6Y.....	E-47
TV26Y.....	E-48
TV16Y.....	E-49

**High Pressure (60,000 psi)**

SV6Y .....	E-50
AV6Y.....	E-51
TV26Y.....	E-52
TV16Y.....	E-53
CV6Y .....	E-54

## Type “M” Swivel Hose Fittings and Adapters

### Features

- Rated for the full working pressure of hose.
- Provides a swivel for quick and easy connection.
- Internal threads and seal are protected from external damage.
- Non rotating seal reduces galling and minimizes tightening torque.
- Can be adapted to almost any connection required.

### Construction

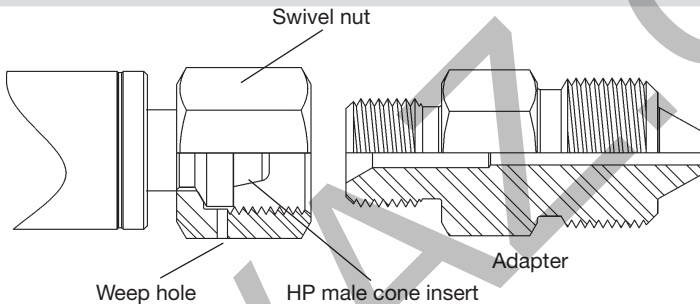

The Type “M” Swivel End Fitting is a swivel nut fitting with a 58° male cone nipple.

***Each Type “M” Swivel End Fitting is rated for the full working pressure of the hose.***

### Sizes

Determined by hose type.

9/16" - 18 thread

3/4" - 16 thread





7/8" - 14 thread

1" - 12 thread

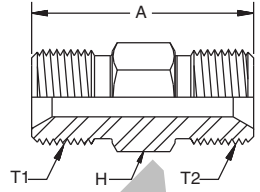
1 5/16" - 12 thread





**YAYA – Type “M” male x Type “M” male**

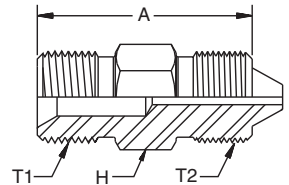

#	 T1	 T2	A					
			mm	inch	mm	inch	MPa	psi
YAYA-6-6C	9/16" - 18 UNF	9/16" - 18 UNF	35.1	1.38	16.0	0.63	413.7	60,000
YAYA-8-6C	3/4" - 16 UNF	9/16" - 18 UNF	41.4	1.63	19.1	0.75	413.7	30,000
YAYA-8-8C	3/4" - 16 UNF	3/4" - 16 UNF	44.5	1.75	19.1	0.75	206.8	30,000
YAYA-10-6C	7/8" - 14 UNF	9/16" - 18 UNF	47.8	1.88	25.4	1.00	413.7	60,000
YAYA-10-10C	7/8" - 14 UNF	7/8" - 14 UNF	50.8	2.00	25.4	1.00	413.7	60,000
YAYA-11-8C	1" - 12 UNF	3/4" - 16 UNF	47.8	1.88	25.4	1.00	206.8	30,000
YAYA-11-11C	1" - 12 UNF	1" - 12 UNF	47.8	1.88	25.4	1.00	206.8	30,000
YAYA-16-11C	1-5/16" - 12 UNF	1" - 12 UNF	54.1	2.13	35.1	1.38	137.9	20,000
YAYA-16-16C	1-5/16" - 12 UNF	1-5/16" - 12 UNF	54.1	2.13	35.1	1.38	137.9	20,000



**YAY6 – Type “M” male x High pressure**



#	 T1	 T2			A							
			DN	size	mm	inch	mm	inch	MPa	psi		
YAY6-6-4C	9/16" - 18 UNF	9/16" - 18 UNF	6	-04	6.4	1/4	38.7	1.53	16.0	0.63	413.7	60,000
YAY6-6-6C	9/16" - 18 UNF	3/4" - 16 UNF	10	-06	9.5	3/8	44.5	1.75	19.1	0.75	413.7	60,000
YAY6-6-9C	9/16" - 18 UNF	1-1/8" - 12 UNF	8	-05	7.9	5/16	50.8	2.00	28.7	1.13	413.7	60,000
YAY6-8-6C	3/4" - 16 UNF	3/4" - 16 UNF	10	-06	9.5	3/8	50.8	2.00	19.1	0.75	206.8	30,000
YAY6-8-9C	3/4" - 16 UNF	1-1/8" - 12 UNF	8	-05	7.9	5/16	57.1	2.25	28.7	1.13	206.8	30,000
YAY6-10-6C	7/8" - 14 UNF	3/4" - 16 UNF	10	-06	9.5	3/8	57.1	2.25	25.4	1.00	413.7	60,000
YAY6-10-9C	7/8" - 14 UNF	1-1/8" - 12 UNF	8	-05	7.9	5/16	60.5	2.38	28.7	1.13	413.7	60,000
YAY6-11-9C	1" - 12 UNF	1-1/8" - 12 UNF	8	-05	7.9	5/16	57.1	2.25	28.7	1.13	206.8	30,000

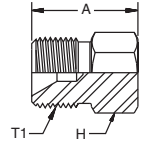

## Plugs

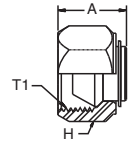

#	 T1	A					
		mm	inch	mm	inch	MPa	psi
YA6C-PLUG	9/16" - 18	52.6	2.07	19.1	0.75	413.7	60,000
YA8C-PLUG	3/4" - 16	54.1	2.13	25.4	1.00	206.8	30,000
YA11C-PLUG	1" - 12	31.8	1.25	25.4	1.00	206.8	30,000
YA16C-PLUG	1 5/16" - 12	66.8	2.63	35.1	1.38	137.9	20,000

## Caps



#	 T1	A					
		mm	inch	mm	inch	MPa	psi
YA6C-CAP	9/16" - 18	21.6	0.85	17.5	0.69	413.7	60,000
YA8C-CAP	3/4" - 16	23.1	0.91	25.4	1.00	206.8	30,000
YA11C-CAP	1" - 12	33.3	1.31	31.8	1.25	206.8	30,000
YA16C-CAP	1 5/16" - 12	30.5	1.20	38.1	1.50	137.9	20,000

**Torpedos**

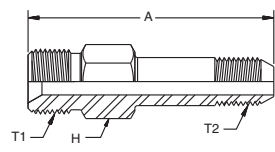

#	T1	T2	A		H		MPa	psi
			mm	inch	mm	inch		
YAY1-8-16C	3/4" - 16	1" - 14LH	90.4	3.56	28.7	1.13	137.9	20,000
YAY2-8-16C	3/4" - 16	1" - 14LH	90.4	3.56	35.1	1.38	137.9	20,000
YAY1-11-16C	1" - 12	1" - 14LH	90.4	3.56	28.7	1.13	137.9	20,000
YAY2-11-16C	1" - 12	1" - 14LH	90.4	3.56	35.1	1.38	137.9	20,000
YAY1-16-16C	1 5/16" - 12	1" - 14LH	94.0	3.70	35.1	1.38	137.9	20,000
YAY2-16-16C	1 5/16" - 12	1" - 14LH	94.0	3.70	35.1	1.38	137.9	20,000

**YAY5 – Type “M” male x Medium pressure**

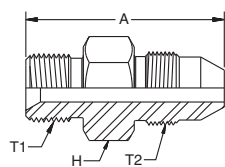



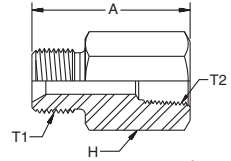

#	T1	T2	O		A		H		MPa	psi		
			DN	size	mm	inch	mm	inch			mm	inch
YAY5-6-4C	9/16" - 18 UNF	7/16" - 20 UNF	6	-04	6.4	1/4	39.6	1.56	16.0	0.63	137.9	20,000
YAY5-6-6C	9/16" - 18 UNF	9/16" - 18 UNF	10	-06	9.5	3/8	41.4	1.63	16.0	0.63	137.9	20,000
YAY5-6-12C	9/16" - 18 UNF	3/4" - 14 NPS	20	-12	19.0	3/4	58.9	2.32	28.7	1.13	137.9	20,000
YAY5-8-6C	3/4" - 16 UNF	9/16" - 18 UNF	10	-06	9.5	3/8	47.8	1.88	19.1	0.75	137.9	20,000
YAY5-8-12C	3/4" - 16 UNF	3/4" - 14 NPS	20	-12	19.0	3/4	62.0	2.44	28.7	1.13	137.9	20,000
YAY5-11-6C	1" - 12 UNF	9/16" - 18 UNF	10	-06	9.5	3/8	50.4	2.00	25.4	1.00	137.9	20,000
YAY5-11-12C	1" - 12 UNF	3/4" - 14 NPS	20	-12	19.0	3/4	62.0	2.44	28.7	1.13	137.9	20,000
YAY5-16-12C	1 5/16" - 12 UNF	13/16" - 16 UNF	20	-12	19.0	3/4	68.6	2.70	35.1	1.38	137.9	20,000

Adapters & Valves

## YA02 – Type "M" male x NPT female





#	 T1	 T2	A					
			mm	inch	mm	inch	MPa	psi
YA02-6-4C	9/16" - 18 UNF	1/4" - 18 UNF	38.1	1.50	19.1	0.75	103.4	15,000
YA02-6-8C	9/16" - 18 UNF	1/2" - 14 UNF	50.8	2.00	31.8	1.25	103.4	15,000
YA02-8-8C	3/4" - 16 UNF	1/2" - 14 UNF	50.8	2.00	31.8	1.25	103.4	15,000
YA02-11-8C	1" - 12 UNF	1/2" - 14 UNF	63.5	2.50	25.4	1.00	103.4	15,000

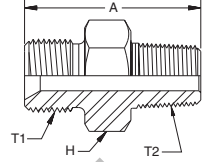

## YA01 – Type “M” male x NPT male



#	 T1	 T2	A		H		MPa	psi
			mm	inch	mm	inch		
YA01-6-2C	9/16" - 18 UNF	1/8" - 27 NPT	32.5	1.28	16.0	0.63	103.4	15,000
YA01-6-4C	9/16" - 18 UNF	1/4" - 18 NPT	35.1	1.38	16.0	0.63	103.4	15,000
YA01-6-6C	9/16" - 18 UNF	3/8" - 18 NPT	39.9	1.57	19.1	0.75	103.4	15,000
YA01-6-8C	9/16" - 18 UNF	1/2" - 14 NPT	44.5	1.75	22.4	0.88	103.4	15,000
YA01-8-4C	3/4" - 16 UNF	1/4" - 18 NPT	45.7	1.80	19.1	0.75	103.4	15,000
YA01-8-6C	3/4" - 16 UNF	3/8" - 18 NPT	43.9	1.73	19.1	0.75	103.4	15,000
YA01-8-8C	3/4" - 16 UNF	1/2" - 14 NPT	49.5	1.95	22.4	0.88	103.4	15,000
YA01-8-12C	3/4" - 16 UNF	3/4" - 12 NPT	54.1	2.13	28.7	1.13	68.9	10,000
YA01-8-16C	3/4" - 16 UNF	1" - 11 1/2 NPT	60.6	2.38	35.1	1.38	68.9	10,000
YA01-11-6C	1" - 12 UNF	3/8" - 18 NPT	47.0	1.85	25.4	1.00	103.4	15,000
YA01-11-8C	1" - 12 UNF	1/2" - 14 NPT	50.8	2.00	25.4	1.00	103.4	15,000
YA01-11-12C	1" - 12 UNF	3/4" - 12 NPT	54.1	2.13	28.7	1.13	68.9	10,000
YA01-11-16C	1" - 12 UNF	1" - 11 1/2 NPT	60.5	2.38	35.1	1.38	68.9	10,000
YA01-16-8C	1 5/16" - 12 UNF	1/2" - 14 NPT	54.1	2.13	35.1	1.38	103.4	15,000
YA01-16-12C	1 5/16" - 12 UNF	3/4" - 12 NPT	60.5	2.38	35.1	1.38	68.9	10,000
YA01-16-16C	1 5/16" - 12 UNF	1" - 11 1/2 NPT	63.5	2.50	35.1	1.38	68.9	10,000
YA01-16-20C	1 5/16" - 12 UNF	1 1/4" - 11 1/2 NPT	69.9	2.75	44.5	1.75	68.9	10,000
YA01-16-24C	1 5/16" - 12 UNF	1 1/4" - 11 1/2 NPT	69.9	2.75	50.8	2.00	51.7	7,500
YA01-16-32C	1 5/16" - 12 UNF	2" - 11 1/2 NPT	69.9	2.75	60.5	2.38	51.7	7,500

## Medium Pressure Fittings & Adapters

### Features

- An industry standard for use at elevated pressures.
- Large orifice allows maximum flow of liquids and gases.
- Suitable for repetitive assembly and disassembly.

### Construction

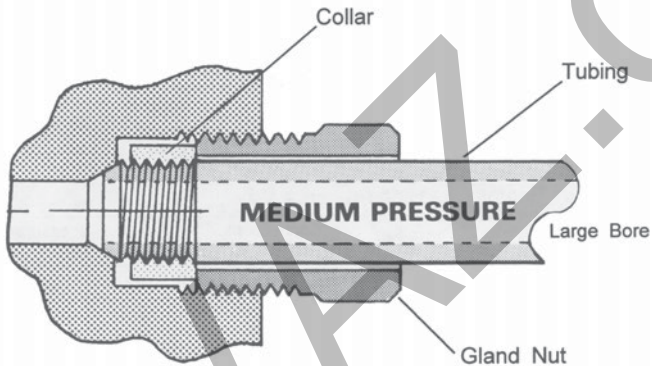

**Medium Pressure** is a 58/60° coned and threaded tubing design. *They have a maximum working pressure rating of 20,000 psi.*

### Sizes

1/4" O.D. x 0.109" I.D. • 7/16" - 20 male thread on gland nut  
3/8" O.D. x 0.19" I.D. • 9/16" - 18 male thread on gland nut  
9/16" O.D. x 0.31" I.D. • 13/16" - 16 male thread on gland nut  
3/4" O.D. x 0.44" I.D. • 3/4" - National Pipe Straight (NPT) male  
1" O.D. x 0.56" I.D. • 1 3/8" - 12 male thread on gland nut

Identification is by tubing O.D.

**5YY5 – Female medium pressure to male medium pressure**

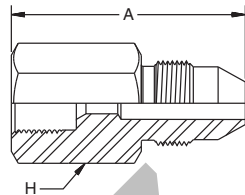



#		A		H		MPa	psi
		mm	inch	mm	inch		
5YY5-4-6C	1/4" M.P. Female to 3/8" M.P. Male	44.5	1.75	19.1	0.75	137.9	20,000
5YY5-4-9C	1/4" M.P. Female to 9/16" M.P. Male	47.5	1.87	22.1	0.87	137.9	20,000
5YY5-4-12C	1/4" M.P. Female to 3/4" M.P. Male	50.8	2.00	28.4	1.12	137.9	20,000
5YY5-4-16C	1/4" M.P. Female to 1" M.P. Male	76.2	3.00	25.4	1.00	137.9	20,000
5YY5-6-4C	3/8" M.P. Female to 1/4" M.P. Male	44.5	1.75	19.1	0.75	137.9	20,000
5YY5-6-9C	3/8" M.P. Female to 9/16" M.P. Male	47.5	1.87	22.1	0.87	137.9	20,000
5YY5-6-12C	3/8" M.P. Female to 3/4" M.P. Male	50.8	2.00	28.4	1.12	137.9	20,000
5YY5-9-4C	9/16" M.P. Female to 1/4" M.P. Male	53.8	2.12	25.4	1.00	137.9	20,000
5YY5-9-6C	9/16" M.P. Female to 3/8" M.P. Male	53.8	2.12	25.4	1.00	137.9	20,000
5YY5-9-12C	9/16" M.P. Female to 3/4" M.P. Male	63.5	2.50	28.4	1.12	137.9	20,000
5YY5-9-16C	9/16" M.P. Female to 1" M.P. Male	85.6	3.37	25.4	1.00	137.9	20,000
5YY5-12-4C	3/4" M.P. Female to 1/4" M.P. Male	31.8	1.25	34.8	1.37	137.9	20,000
5YY5-12-6C	3/4" M.P. Female to 3/8" M.P. Male	60.2	2.37	34.8	1.37	137.9	20,000
5YY5-12-9C	3/4" M.P. Female to 9/16" M.P. Male	72.9	2.87	34.8	1.37	137.9	20,000
5YY5-12-16C	3/4" M.P. Female to 1" M.P. Male	95.3	3.75	34.8	1.37	137.9	20,000
5YY5-16-4C	1" M.P. Female to 1/4" M.P. Male	69.9	2.75	44.5	1.75	137.9	20,000
5YY5-16-6C	1" M.P. Female to 3/8" M.P. Male	72.9	2.87	44.5	1.75	137.9	20,000
5YY5-16-9C	1" M.P. Female to 9/16" M.P. Male	76.2	3.00	44.5	1.75	137.9	20,000
5YY5-16-12C	1" M.P. Female to 3/4" M.P. Male	82.6	3.25	44.5	1.75	137.9	20,000

Adapters & Valves

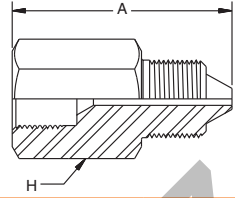
## 5YY6 – Female medium pressure to male high pressure



#		A					
		mm	inch	mm	inch	MPa	psi
5YY6-4-4C	1/4" M.P. Female to 1/4" H.P. Male	34.8	1.37	19.1	0.75	137.9	20,000
5YY6-4-6C	1/4" M.P. Female to 3/8" H.P. Male	44.5	1.75	19.1	0.75	137.9	20,000
5YY6-4-9C	1/4" M.P. Female to 9/16" H.P. Male	53.8	2.12	28.4	1.12	137.9	20,000
5YY6-6-4C	3/8" M.P. Female to 1/4" H.P. Male	44.5	1.75	19.1	0.75	137.9	20,000
5YY6-6-6C	3/8" M.P. Female to 3/8" H.P. Male	44.5	1.75	19.1	0.75	137.9	20,000
5YY6-6-9C	3/8" M.P. Female to 9/16" H.P. Male	53.8	2.12	28.4	1.12	137.9	20,000
5YY6-9-4C	9/16" M.P. Female to 1/4" H.P. Male	47.5	1.87	25.4	1.00	137.9	20,000
5YY6-9-6C	9/16" M.P. Female to 3/8" H.P. Male	53.8	2.12	25.4	1.00	137.9	20,000
5YY6-9-9C	9/16" M.P. Female to 9/16" H.P. Male	53.8	2.12	28.4	1.12	137.9	20,000
5YY6-12-4C	3/4" M.P. Female to 1/4" H.P. Male	63.5	2.50	34.8	1.37	137.9	20,000
5YY6-12-6C	3/4" M.P. Female to 3/8" H.P. Male	60.2	2.37	34.8	1.37	137.9	20,000
5YY6-12-9C	3/4" M.P. Female to 9/16" H.P. Male	66.5	2.62	34.8	1.37	137.9	20,000
5YY6-16-6C	1" M.P. Female to 3/8" H.P. Male	72.9	2.87	44.5	1.75	137.9	20,000
5YY6-16-9C	1" M.P. Female to 9/16" H.P. Male	79.2	3.12	44.5	1.75	137.9	20,000



**6YY5 – Female high pressure  
to male medium pressure**

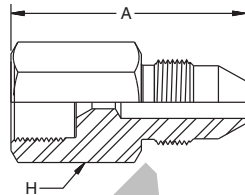



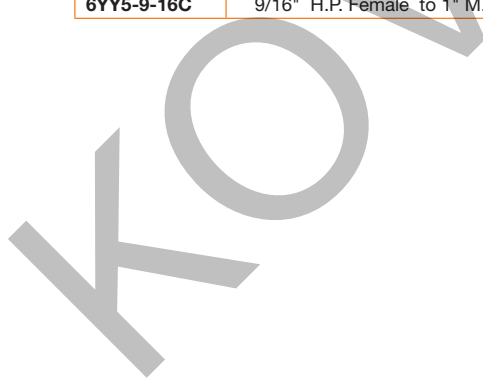

#		A		H		MPa	psi
		mm	inch	mm	inch		
6YY5-4-4C	1/4" H.P. Female to 1/4" M.P. Male	44.5	1.75	19.1	0.75	137.9	20,000
6YY5-4-6C	1/4" H.P. Female to 3/8" M.P. Male	44.5	1.75	19.1	0.75	137.9	20,000
6YY5-4-9C	1/4" H.P. Female to 9/16" M.P. Male	47.5	1.87	22.1	0.87	137.9	20,000
6YY5-4-12C	1/4" H.P. Female to 3/4" M.P. Male	57.2	2.25	28.4	1.12	137.9	20,000
6YY5-4-16C	1/4" H.P. Female to 1" M.P. Male	76.2	3.00	25.4	1.00	137.9	20,000
6YY5-6-4C	3/8" H.P. Female to 1/4" M.P. Male	47.5	1.87	25.4	1.00	137.9	20,000
6YY5-6-6C	3/8" H.P. Female to 3/8" M.P. Male	47.5	1.87	25.4	1.00	137.9	20,000
6YY5-6-9C	3/8" H.P. Female to 9/16" M.P. Male	50.8	2.00	25.4	1.00	137.9	20,000
6YY5-6-12C	3/8" H.P. Female to 3/4" M.P. Male	57.2	2.25	28.4	1.12	137.9	20,000
6YY5-6-16C	3/8" H.P. Female to 1" M.P. Male	82.6	3.25	25.4	1.00	137.9	20,000
6YY5-9-4C	9/16" H.P. Female to 1/4" M.P. Male	53.8	2.12	34.8	1.37	137.9	20,000
6YY5-9-6C	9/16" H.P. Female to 3/8" M.P. Male	53.8	2.12	34.8	1.37	137.9	20,000
6YY5-9-9C	9/16" H.P. Female to 9/16" M.P. Male	60.2	2.37	34.8	1.37	137.9	20,000
6YY5-9-12C	9/16" H.P. Female to 3/4" M.P. Male	63.5	2.50	34.8	1.37	137.9	20,000
6YY5-9-16C	9/16" H.P. Female to 1" M.P. Male	91.1	3.62	34.8	1.37	137.9	20,000

Adapters & Valves

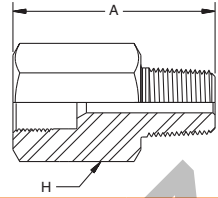



## 5Y01 – Female medium pressure to NPT male

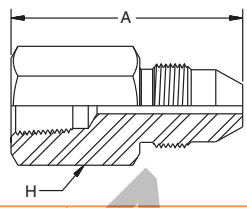

#		A					
		mm	inch	mm	inch	MPa	psi
5Y01-4-2C	1/4" M.P. Female to 1/8" NPT Male	36.3	1.43	19.1	0.75	139.7	15,000
5Y01-4-4C	1/4" M.P. Female to 1/4" NPT Male	41.1	1.62	19.1	0.75	139.7	15,000
5Y01-4-6C	1/4" M.P. Female to 3/8" NPT Male	41.1	1.62	19.1	0.75	139.7	15,000
5Y01-4-8C	1/4" M.P. Female to 1/2" NPT Male	44.5	1.75	25.4	1.00	139.7	15,000
5Y01-4-12C	1/4" M.P. Female to 3/4" NPT Male	47.5	1.87	34.8	1.37	103.4	10,000
5Y01-4-16C	1/4" M.P. Female to 1" NPT Male	47.5	1.87	34.8	1.37	103.4	10,000
5Y01-6-2C	3/8" M.P. Female to 1/8" NPT Male	36.3	1.43	19.1	0.75	139.7	15,000
5Y01-6-4C	3/8" M.P. Female to 1/4" NPT Male	41.1	1.62	19.1	0.75	139.7	15,000
5Y01-6-6C	3/8" M.P. Female to 3/8" NPT Male	41.1	1.62	19.1	0.75	139.7	15,000
5Y01-6-8C	3/8" M.P. Female to 1/2" NPT Male	44.2	1.74	25.4	1.00	139.7	15,000
5Y01-6-12C	3/8" M.P. Female to 3/4" NPT Male	47.5	1.87	34.8	1.37	103.4	10,000
5Y01-6-16C	3/8" M.P. Female to 1" NPT Male	47.5	1.87	34.8	1.37	103.4	10,000
5Y01-9-2C	9/16" M.P. Female to 1/4" NPT Male	47.5	1.87	25.4	1.00	139.7	15,000
5Y01-9-4C	9/16" M.P. Female to 1/4" NPT Male	47.5	1.87	25.4	1.00	139.7	15,000
5Y01-9-6C	9/16" M.P. Female to 3/8" NPT Male	47.5	1.87	25.4	1.00	139.7	15,000
5Y01-9-8C	9/16" M.P. Female to 1/2" NPT Male	47.5	1.87	25.4	1.00	139.7	15,000
5Y01-9-12C	9/16" M.P. Female to 3/4" NPT Male	47.5	1.87	34.8	1.37	103.4	10,000
5Y01-9-16C	9/16" M.P. Female to 1" NPT Male	47.5	1.87	34.8	1.37	103.4	10,000
5Y01-12-2C	3/4" M.P. Female to 1/8" NPT Male	63.5	2.50	34.8	1.37	139.7	15,000
5Y01-12-4C	3/4" M.P. Female to 1/4" NPT Male	63.5	2.50	34.8	1.37	139.7	15,000
5Y01-12-6C	3/4" M.P. Female to 3/8" NPT Male	63.5	2.50	34.8	1.37	139.7	15,000
5Y01-12-8C	3/4" M.P. Female to 1/2" NPT Male	63.5	2.50	34.8	1.37	139.7	15,000
5Y01-12-12C	3/4" M.P. Female to 3/4" NPT Male	63.5	2.50	34.8	1.37	139.7	15,000
5Y01-12-16C	3/4" M.P. Female to 1" NPT Male	63.5	2.50	34.8	1.37	139.7	15,000
5Y01-16-2C	1" M.P. Female to 1/8" NPT Male	63.5	2.50	34.8	1.37	139.7	15,000
5Y01-16-4C	1" M.P. Female to 1/4" NPT Male	63.5	2.50	34.8	1.37	139.7	15,000
5Y01-16-6C	1" M.P. Female to 3/8" NPT Male	63.5	2.50	34.8	1.37	139.7	15,000
5Y01-16-8C	1" M.P. Female to 1/2" NPT Male	63.5	2.50	34.8	1.37	139.7	15,000
5Y01-16-12C	1" M.P. Female to 3/4" NPT Male	63.5	2.50	34.8	1.37	139.7	15,000
5Y01-16-16C	1" M.P. Female to 1" NPT Male	63.5	2.50	34.8	1.37	103.4	10,000

## 02Y5 – Female NPT to male medium pressure





#		A		H		Pressure	
		mm	inch	mm	inch	MPa	psi
02Y5-2-12C	1/8" NPT Female to 3/4" M.P. Male	50.8	2.00	28.4	1.12	103.4	15,000
02Y5-2-16C	1/8" NPT Female to 1" M.P. Male	76.2	3.00	25.4	1.00	103.4	15,000
02Y5-2-4C	1/8" NPT Female to 1/4" M.P. Male	44.5	1.75	19.1	0.75	103.4	15,000
02Y5-2-6C	1/8" NPT Female to 3/8" M.P. Male	47.5	1.87	19.1	0.75	103.4	15,000
02Y5-2-9C	1/8" NPT Female to 9/16" M.P. Male	47.5	1.87	22.1	0.87	103.4	15,000
02Y5-4-4C	1/4" NPT Female to 1/4" M.P. Male	44.5	1.75	19.1	0.75	103.4	15,000
02Y5-4-6C	1/4" NPT Female to 3/8" M.P. Male	47.5	1.87	19.1	0.75	103.4	15,000
02Y5-4-9C	1/4" NPT Female to 9/16" M.P. Male	47.5	1.87	22.1	0.87	103.4	15,000
02Y5-4-12C	1/4" NPT Female to 3/4" M.P. Male	50.8	2.00	28.4	1.12	103.4	15,000
02Y5-4-16C	1/4" NPT Female to 1" M.P. Male	76.2	3.00	25.4	1.00	103.4	15,000
02Y5-6-4C	3/8" NPT Female to 1/4" M.P. Male	50.8	2.00	25.4	1.00	103.4	15,000
02Y5-6-6C	3/8" NPT Female to 3/8" M.P. Male	53.8	2.12	25.4	1.00	103.4	15,000
02Y5-6-9C	3/8" NPT Female to 9/16" M.P. Male	57.2	2.25	25.4	1.00	103.4	15,000
02Y5-6-12C	3/8" NPT Female to 3/4" M.P. Male	50.8	2.00	28.4	1.12	103.4	15,000
02Y5-6-16C	3/8" NPT Female to 1" M.P. Male	76.2	3.00	25.4	1.00	103.4	15,000
02Y5-8-4C	1/2" NPT Female to 1/4" M.P. Male	53.8	2.12	28.4	1.12	103.4	15,000
02Y5-8-6C	1/2" NPT Female to 3/8" M.P. Male	31.8	1.25	28.4	1.12	103.4	15,000
02Y5-8-8C	1/2" NPT Female to 9/16" M.P. Male	60.2	2.37	28.4	1.12	103.4	15,000
02Y5-8-12C	1/2" NPT Female to 3/4" M.P. Male	63.5	2.50	28.4	1.12	103.4	15,000
02Y5-8-16C	1/2" NPT Female to 1" M.P. Male	95.3	3.75	28.4	1.12	103.4	15,000
02Y5-12-4C	3/4" NPT Female to 1/4" M.P. Male	60.2	2.37	34.8	1.37	68.9	10,000
02Y5-12-6C	3/4" NPT Female to 3/8" M.P. Male	63.5	2.50	34.8	1.37	68.9	10,000
02Y5-12-9C	3/4" NPT Female to 9/16" M.P. Male	66.5	2.62	34.8	1.37	68.9	10,000
02Y5-12-12C	3/4" NPT Female to 3/4" M.P. Male	69.9	2.75	38.1	1.50	68.9	10,000
02Y5-12-16C	3/4" NPT Female to 1" M.P. Male	104.6	4.12	38.1	1.50	68.9	10,000
02Y5-16-6C	1" NPT Female to 3/8" M.P. Male	72.9	2.87	47.5	1.87	68.9	10,000
02Y5-16-9C	1" NPT Female to 9/16" M.P. Male	76.2	3.00	47.5	1.87	68.9	10,000
02Y5-16-12C	1" NPT Female to 3/4" M.P. Male	76.2	3.00	47.5	1.87	68.9	10,000
02Y5-16-16C	1" NPT Female to 1" M.P. Male	111.0	4.37	47.5	1.87	68.9	10,000

Adapters & Valves

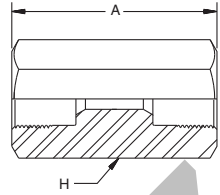

## 5Y5Y – Straight coupling

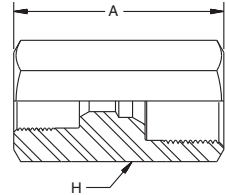

#		A		H			
		mm	inch	mm	inch	MPa	psi
5Y5Y-4-4C	1/4" Medium pressure female	41.1	1.62	19.1	0.75	137.9	20,000
5Y5Y-6-6C	3/8" Medium pressure female	44.5	1.75	19.1	0.75	137.9	20,000
5Y5Y-9-9C	9/16" Medium pressure female	53.8	2.12	25.4	1.00	137.9	20,000
5Y5Y-12-12C	3/4" Medium pressure female	63.5	2.50	34.8	1.37	137.9	20,000
5Y5Y-16-16C	1" Medium pressure female	88.9	3.50	44.5	1.75	137.9	20,000

## 5Y5Y – Reducer coupling



#		A		H			
		mm	inch	mm	inch	MPa	psi
5Y5Y-4-6C	1/4" M.P. Female to 3/8" M.P. Female	44.5	1.75	19.1	0.75	137.9	20,000
5Y5Y-4-9C	1/4" M.P. Female to 9/16" M.P. Female	53.8	2.12	25.4	1.00	137.9	20,000
5Y5Y-4-12C	1/4" M.P. Female to 3/4" M.P. Female	63.5	2.50	34.8	1.37	137.9	20,000
5Y5Y-4-16C	1/4" M.P. Female to 1" M.P. Female	88.9	3.50	44.5	1.75	137.9	20,000
5Y5Y-6-9C	3/8" M.P. Female to 9/16" M.P. Female	53.8	2.12	25.4	1.00	137.9	20,000
5Y5Y-6-12C	3/8" M.P. Female to 3/4" M.P. Female	63.5	2.50	34.8	1.37	137.9	20,000
5Y5Y-6-16C	3/8" M.P. Female to 1" M.P. Female	88.9	3.50	44.5	1.75	137.9	20,000
5Y5Y-9-12C	9/16" M.P. Female to 3/4" M.P. Female	63.5	2.50	34.8	1.37	137.9	20,000
5Y5Y-9-16C	9/16" M.P. Female to 1" M.P. Female	88.9	3.50	44.5	1.75	137.9	20,000
5Y5Y-12-16C	3/4" M.P. Female to 1" M.P. Female	88.9	3.50	44.5	1.75	137.9	20,000



**5Y6Y – Female medium pressure  
to female high pressure coupling**

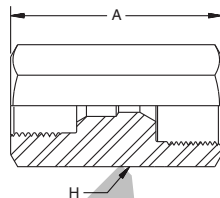



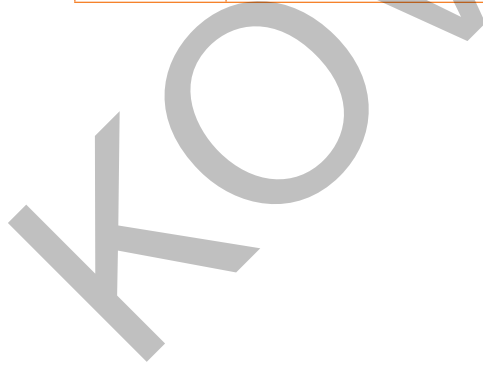

#		A		H		MPa	psi
		mm	inch	mm	inch		
5Y6Y-4-4C	1/4" M.P. Female to 1/4" H.P. Female	41.1	1.62	19.1	0.75	137.9	20,000
5Y6Y-4-6C	1/4" M.P. Female to 3/8" H.P. Female	47.5	1.87	25.4	1.00	137.9	20,000
5Y6Y-4-9C	1/4" M.P. Female to 9/16" H.P. Female	60.2	2.37	34.8	1.37	137.9	20,000
5Y6Y-6-4C	3/8" M.P. Female to 1/4" H.P. Female	44.5	1.75	19.1	0.75	137.9	20,000
5Y6Y-6-6C	3/8" M.P. Female to 3/8" H.P. Female	47.5	1.87	25.4	1.00	137.9	20,000
5Y6Y-6-9C	3/8" M.P. Female to 9/16" H.P. Female	60.2	2.37	34.8	1.37	137.9	20,000
5Y6Y-9-4C	9/16" M.P. Female to 1/4" H.P. Female	53.8	2.12	25.4	1.00	137.9	20,000
5Y6Y-9-6C	9/16" M.P. Female to 3/8" H.P. Female	53.8	2.12	25.4	1.00	137.9	20,000
5Y6Y-9-9C	9/16" M.P. Female to 9/16" H.P. Female	60.2	2.37	34.8	1.37	137.9	20,000
5Y6Y-12-4C	3/4" M.P. Female to 1/4" H.P. Female	63.5	2.50	34.8	1.37	137.9	20,000
5Y6Y-12-6C	3/4" M.P. Female to 3/8" H.P. Female	63.5	2.50	34.8	1.37	137.9	20,000
5Y6Y-12-9C	3/4" M.P. Female to 9/16" H.P. Female	63.5	2.50	34.8	1.37	137.9	20,000
5Y6Y-16-4C	1" M.P. Female to 1/4" H.P. Female	88.9	3.50	34.8	1.37	137.9	20,000
5Y6Y-16-6C	1" M.P. Female to 3/8" H.P. Female	88.9	3.50	34.8	1.37	137.9	20,000
5Y6Y-16-9C	1" M.P. Female to 9/16" H.P. Female	88.9	3.50	34.8	1.37	137.9	20,000

Adapters & Valves

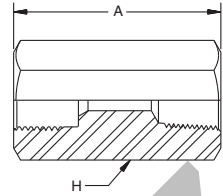

## 5Y02 – Female medium pressure to NPT female coupling

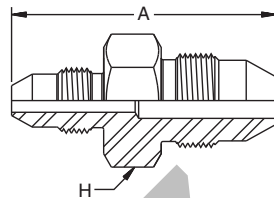

#		A					
		mm	inch	mm	inch	MPa	psi
5Y02-4-2C	1/4" M.P. Female to 1/8" NPT Female	41.1	1.62	19.1	0.75	103.4	15,000
5Y02-4-4C	1/4" M.P. Female to 1/4" NPT Female	41.1	1.62	19.1	0.75	103.4	15,000
5Y02-4-6C	1/4" M.P. Female to 3/8" NPT Female	50.8	2.00	25.4	1.00	103.4	15,000
5Y02-4-8C	1/4" M.P. Female to 1/2" NPT Female	50.8	2.00	28.4	1.12	103.4	15,000
5Y02-4-12C	1/4" M.P. Female to 3/4" NPT Female	60.2	2.37	34.8	1.37	68.9	10,000
5Y02-4-16C	1/4" M.P. Female to 1" NPT Female	66.5	2.62	50.8	2.00	68.9	10,000
5Y02-6-2C	3/8" M.P. Female to 1/8" NPT Female	44.5	1.75	19.1	0.75	103.4	15,000
5Y02-6-4C	3/8" M.P. Female to 1/4" NPT Female	44.5	1.75	19.1	0.75	103.4	15,000
5Y02-6-6C	3/8" M.P. Female to 3/8" NPT Female	53.8	2.12	25.4	1.00	103.4	15,000
5Y02-6-8C	3/8" M.P. Female to 1/2" NPT Female	53.8	2.12	28.4	1.12	103.4	15,000
5Y02-6-12C	3/8" M.P. Female to 3/4" NPT Female	60.2	2.37	34.8	1.37	68.9	10,000
5Y02-6-16C	3/8" M.P. Female to 1" NPT Female	69.9	2.75	50.8	2.00	68.9	10,000
5Y02-9-2C	9/16" M.P. Female to 1/8" NPT Female	53.8	2.12	25.4	1.00	103.4	15,000
5Y02-9-4C	9/16" M.P. Female to 1/4" NPT Female	53.8	2.12	25.4	1.00	103.4	15,000
5Y02-9-6C	9/16" M.P. Female to 3/8" NPT Female	53.8	2.12	25.4	1.00	103.4	15,000
5Y02-9-8C	9/16" M.P. Female to 1/2" NPT Female	57.2	2.25	28.4	1.12	103.4	15,000
5Y02-9-12C	9/16" M.P. Female to 3/4" NPT Female	63.5	2.50	34.8	1.37	68.9	10,000
5Y02-9-16C	9/16" M.P. Female to 1" NPT Female	72.9	2.87	50.8	2.00	68.9	10,000
5Y02-12-2C	3/4" M.P. Female to 1/8" NPT Female	63.5	2.50	34.8	1.37	103.4	15,000
5Y02-12-4C	3/4" M.P. Female to 1/4" NPT Female	63.5	2.50	34.8	1.37	103.4	15,000
5Y02-12-6C	3/4" M.P. Female to 3/8" NPT Female	63.5	2.50	34.8	1.37	103.4	15,000
5Y02-12-8C	3/4" M.P. Female to 1/2" NPT Female	63.5	2.50	34.8	1.37	103.4	15,000
5Y02-12-12C	3/4" M.P. Female to 3/4" NPT Female	69.9	2.75	38.1	1.50	68.9	10,000
5Y02-12-16C	3/4" M.P. Female to 1" NPT Female	76.2	3.00	47.5	1.87	68.9	10,000
5Y02-16-2C	1" M.P. Female to 1/8" NPT Female	76.2	3.00	44.5	1.75	103.4	15,000
5Y02-16-4C	1" M.P. Female to 1/4" NPT Female	76.2	3.00	44.5	1.75	103.4	15,000
5Y02-16-6C	1" M.P. Female to 3/8" NPT Female	76.2	3.00	44.5	1.75	103.4	15,000
5Y02-16-8C	1" M.P. Female to 1/2" NPT Female	76.2	3.00	44.5	1.75	103.4	15,000
5Y02-16-12C	1" M.P. Female to 3/4" NPT Female	88.9	3.50	38.1	1.50	68.9	10,000
5Y02-16-16C	1" M.P. Female to 1" NPT Female	95.2	3.75	47.5	1.87	68.9	10,000

**Y5Y5 – Male medium pressure  
to male medium pressure**

#		A		H			
		mm	inch	mm	inch	MPa	psi
Y5Y5-4-4C	1/4" M.P. Male to 1/4" M.P. Male	50.8	2.00	15.7	0.62	137.9	20,000
Y5Y5-4-6C	1/4" M.P. Male to 3/8" M.P. Male	53.8	2.12	19.1	0.75	137.9	20,000
Y5Y5-4-12C	1/4" M.P. Male to 3/4" M.P. Male	50.8	2.50	28.4	1.12	137.9	20,000
Y5Y5-4-16C	1/4" M.P. Male to 1" M.P. Male	91.9	3.62	25.4	1.00	137.9	20,000
Y5Y5-6-6C	3/8" M.P. Male to 3/8" M.P. Male	57.2	2.25	19.1	0.75	137.9	20,000
Y5Y5-6-9C	3/8" M.P. Male to 9/16" M.P. Male	63.5	2.50	22.1	0.87	137.9	20,000
Y5Y5-6-12C	3/8" M.P. Male to 3/4" M.P. Male	66.5	2.62	28.4	1.12	137.9	20,000
Y5Y5-6-16C	3/8" M.P. Male to 1" M.P. Male	95.3	3.75	25.4	1.00	137.9	20,000
Y5Y5-9-9C	9/16" M.P. Male to 9/16" M.P. Male	63.5	2.50	25.4	1.00	137.9	20,000
Y5Y5-9-12C	9/16" M.P. Male to 3/4" M.P. Male	72.9	2.87	28.4	1.12	137.9	20,000
Y5Y5-9-16C	9/16" M.P. Male to 1" M.P. Male	101.6	4.00	25.4	1.00	137.9	20,000
Y5Y5-12-12C	3/4" M.P. Male to 3/4" M.P. Male	76.2	3.00	28.4	1.12	137.9	20,000
Y5Y5-12-16C	3/4" M.P. Male to 1" M.P. Male	31.8	1.25	28.4	1.12	137.9	20,000

## Y5Y6 – Male medium pressure to male high pressure

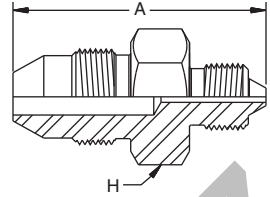

#		A					
		mm	inch	mm	inch	MPa	psi
Y5Y6-4-4C	1/4" M.P. Male to 1/4" H.P. Male	43.9	1.73	16.0	0.63	137.9	20,000
Y5Y6-4-6C	1/4" M.P. Male to 3/8" H.P. Male	53.3	2.10	19.1	0.75	137.9	20,000
Y5Y6-4-9C	1/4" M.P. Male to 9/16" H.P. Male	60.2	2.37	28.4	1.12	137.9	20,000
Y5Y6-6-4C	3/8" M.P. Male to 1/4" H.P. Male	53.8	2.12	15.7	0.62	137.9	20,000
Y5Y6-6-9C	3/8" M.P. Male to 9/16" H.P. Male	63.5	2.50	28.4	1.12	137.9	20,000
Y5Y6-9-4C	9/16" M.P. Male to 1/4" H.P. Male	57.2	2.25	22.1	0.87	137.9	20,000
Y5Y6-9-9C	9/16" M.P. Male to 9/16" H.P. Male	66.5	2.62	28.4	1.12	137.9	20,000
Y5Y6-12-4C	3/4" M.P. Male to 1/4" H.P. Male	66.5	2.62	28.4	1.12	137.9	20,000
Y5Y6-12-6C	3/4" M.P. Male to 3/8" H.P. Male	69.9	2.75	28.4	1.12	137.9	20,000
Y5Y6-12-9C	3/4" M.P. Male to 9/16" H.P. Male	76.2	3.00	28.4	1.12	137.9	20,000
Y5Y6-16-4C	1" M.P. Male to 1/4" H.P. Male	91.9	3.62	25.4	1.00	137.9	20,000
Y5Y6-16-6C	1" M.P. Male to 3/8" H.P. Male	101.6	4.00	25.4	1.00	137.9	20,000
Y5Y6-16-9C	1" M.P. Male to 9/16" H.P. Male	101.6	4.00	28.4	1.12	137.9	20,000

### Y501 – Male medium pressure to NPT male

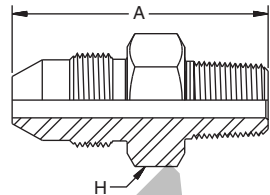

#		A		H		MPa	psi
		mm	inch	mm	inch		
Y501-4-4C	1/4" M.P. Male to 1/4" NPT Male	40.6	1.60	16.0	0.63	103.4	15,000
Y501-4-8C	1/4" M.P. Male to 1/2" NPT Male	53.8	2.12	22.1	0.87	103.4	15,000
Y501-6-4C	3/8" M.P. Male to 1/4" NPT Male	52.3	2.06	19.1	0.75	103.4	15,000
Y501-6-6C	3/8" M.P. Male to 3/8" NPT Male	52.3	2.06	19.1	0.75	103.4	15,000
Y501-6-8C	3/8" M.P. Male to 1/2" NPT Male	55.4	2.18	22.1	0.87	103.4	15,000
Y501-9-2C	9/16" M.P. Male to 1/8" NPT Male	53.8	2.12	22.1	0.87	103.4	15,000
Y501-9-4C	9/16" M.P. Male to 1/4" NPT Male	57.2	2.25	22.1	0.87	103.4	15,000
Y501-9-6C	9/16" M.P. Male to 3/8" NPT Male	57.2	2.25	22.1	0.87	103.4	15,000
Y501-9-8C	9/16" M.P. Male to 1/2" NPT Male	60.2	2.37	22.1	0.87	103.4	15,000
Y501-9-12C	9/16" M.P. Male to 3/4" NPT Male	66.5	2.62	28.4	1.12	68.9	10,000
Y501-9-16C	9/16" M.P. Male to 1" NPT Male	66.5	2.62	34.8	1.37	68.9	10,000
Y501-12-2C	3/4" M.P. Male to 1/8" NPT Male	60.2	2.37	28.4	1.12	103.4	15,000
Y501-12-4C	3/4" M.P. Male to 1/4" NPT Male	63.5	2.50	28.4	1.12	103.4	15,000
Y501-12-6C	3/4" M.P. Male to 3/8" NPT Male	63.5	2.50	28.4	1.12	103.4	15,000
Y501-12-8C	3/4" M.P. Male to 1/2" NPT Male	66.5	2.62	28.4	1.12	103.4	15,000
Y501-12-12C	3/4" M.P. Male to 3/4" NPT Male	69.9	2.75	28.4	1.12	68.9	10,000
Y501-12-16C	3/4" M.P. Male to 1" NPT Male	76.2	3.00	34.8	1.37	68.9	10,000
Y501-16-2C	1" M.P. Male to 1/8" NPT Male	91.9	3.62	25.4	1.00	103.4	15,000
Y501-16-4C	1" M.P. Male to 1/4" NPT Male	95.2	3.75	25.4	1.00	103.4	15,000
Y501-16-6C	1" M.P. Male to 3/8" NPT Male	95.2	3.75	25.4	1.00	103.4	15,000
Y501-16-8C	1" M.P. Male to 1/2" NPT Male	98.3	3.87	25.4	1.00	103.4	15,000
Y501-16-12C	1" M.P. Male to 3/4" NPT Male	98.3	3.87	28.4	1.12	68.9	10,000
Y501-16-16C	1" M.P. Male to 1" NPT Male	101.6	4.00	34.8	1.37	68.9	10,000

Adapters & Valves

## L5Y – Medium pressure elbow

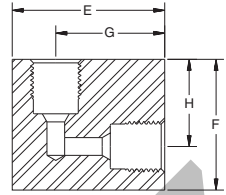

#				E		F		G		H			
		mm	inch	mm	inch	mm	inch	mm	inch	mm	inch	MPa	psi
L5Y-4C	1/4" M.P.	19.1	0.75	30.0	1.18	25.4	1.00	22.1	0.87	17.3	0.68	137.9	20,000
L5Y-6C	3/8" M.P.	19.1	0.75	34.8	1.37	34.8	1.37	25.4	1.00	25.4	1.00	137.9	20,000
L5Y-9C	9/16" M.P.	25.4	1.00	44.5	1.75	44.5	1.75	31.8	1.25	31.8	1.25	137.9	20,000
L5Y-12C	3/4" M.P.	34.8	1.37	57.2	2.25	57.2	2.25	38.1	1.50	38.1	1.50	137.9	20,000
L5Y-16C	1" M.P.	44.5	1.75	76.2	3.00	76.2	3.00	52.3	2.06	52.3	2.06	137.9	20,000

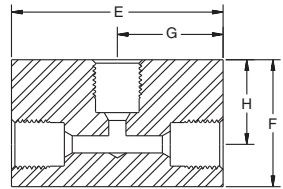

## T5Y – Medium pressure elbow



#				E		F		G		H			
		mm	inch	mm	inch	mm	inch	mm	inch	mm	inch	MPa	psi
T5Y-4C	1/4" M.P.	15.7	0.62	44.5	1.75	25.4	1.00	22.1	0.87	17.3	0.68	137.9	20,000
T5Y-6C	3/8" M.P.	19.1	0.75	50.8	2.00	34.8	1.37	25.4	1.00	25.4	1.00	137.9	20,000
T5Y-9C	9/16" M.P.	25.4	1.00	63.5	2.50	44.5	1.75	31.8	1.25	31.8	1.25	137.9	20,000
T5Y-12C	3/4" M.P.	34.8	1.37	76.2	3.00	57.2	2.25	38.1	1.50	38.1	1.50	137.9	20,000
T5Y-16C	1" M.P.	44.5	1.75	104.6	4.12	76.2	3.00	52.3	2.06	52.3	2.06	137.9	20,000

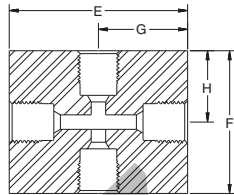

### X5Y – Medium pressure elbow



#				E		F		G		H			
		mm	inch	mm	inch	mm	inch	mm	inch	mm	inch	MPa	psi
X5Y-4C	1/4" M.P.	15.7	0.62	44.5	1.75	34.8	1.37	22.1	0.87	17.3	0.68	137.9	20,000
X5Y-6C	3/8" M.P.	19.1	0.75	50.8	2.00	50.8	2.00	25.4	1.00	25.4	1.00	137.9	20,000
X5Y-9C	9/16" M.P.	25.4	1.00	63.5	2.50	63.5	2.50	31.8	1.25	31.8	1.25	137.9	20,000
X5Y-12C	3/4" M.P.	34.8	1.37	76.2	3.00	76.2	3.00	38.1	1.50	38.1	1.50	137.9	20,000
X5Y-16C	1" M.P.	44.5	1.75	104.6	4.12	104.6	4.12	52.3	2.06	52.3	2.06	137.9	20,000

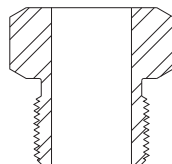

### Y2N – Medium pressure gland nut



#			
		MPa	psi
Y2N-4C	1/4" M.P.	137.9	20,000
Y2N-6C	3/8" M.P.	137.9	20,000
Y2N-9C	9/16" M.P.	137.9	20,000
Y2N-12C	3/4" M.P.	137.9	20,000
Y2N-16C	1" M.P.	137.9	20,000



## Y2C – Medium pressure collar

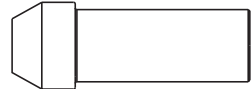

#			
		MPa	psi
Y2C-4C	1/4" M.P.	137.9	20,000
Y2C-6C	3/8" M.P.	137.9	20,000
Y2C-9C	9/16" M.P.	137.9	20,000
Y2C-12C	3/4" M.P.	137.9	20,000
Y2C-16C	1" M.P.	137.9	20,000

## HBPLM – Medium pressure plug



#			
		MPa	psi
HBPLM4-B	1/4" M.P.	137.9	20,000
HBPLM6-B	3/8" M.P.	137.9	20,000
HBPLM9-B	9/16" M.P.	137.9	20,000
HBPLM12-B	3/4" M.P.	137.9	20,000
HBPLM16-B	1" M.P.	137.9	20,000

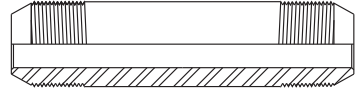

**Y204, Y206, Y209, Y212 and Y216 –  
Medium pressure nipple**

Length		#	#	#	#	#
mm	inch	1/4" O.D.	3/8" O.D.	9/16" O.D.	3/4" O.D.	1" O.D.
69.9	2.75	Y204-0275C	–	–	–	–
72.2	3.00	Y204-0300C	Y206-0300C	–	–	–
101.6	4.00	Y204-0400C	Y206-0400C	Y209-0400C	Y212-0400C	–
152.4	6.00	Y204-0600C	Y206-0600C	Y209-0600C	Y212-0600C	Y216-0600C
203.2	8.00	Y204-0800C	Y206-0800C	Y209-0800C	Y212-0800C	Y216-0800C
254.0	10.00	Y204-1000C	Y206-1000C	Y209-1000C	Y212-1000C	Y216-1000C
304.8	12.00	Y204-1200C	Y206-1200C	Y209-1200C	Y212-1200C	Y216-1200C

## High Pressure Fittings & Adapters

### Features

- An industry standard for use at elevated pressures.
- Suitable for repetitive assembly and disassembly.

### Construction

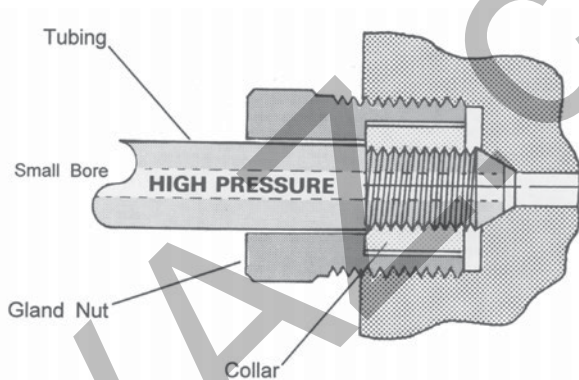

**High Pressure** is a 58/60 degree coned and threaded tubing design.  
**With small bore sizes, they have a maximum working pressure rating of 60,000 psi.**

### Sizes

1/4" O.D. x 0.08" I.D. • 9/16" - 18 male thread on gland nut  
3/8" O.D. x 0.12" I.D. • 3/4" - 16 male thread on gland nut  
9/16" O.D. x 0.18" I.D. • 1 1/8" - 12 male thread on gland nut

Identification is by tubing O.D.

**6YY6 – Female high pressure  
to male high pressure**

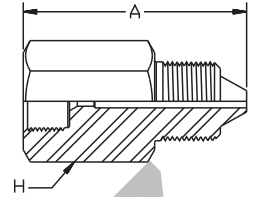

#		A					
		mm	inch	mm	inch	MPa	psi
6YY6-4-6C	1/4" H.P. Female to 3/8" H.P.	44.5	1.75	19.1	0.75	413.7	60,000
6YY6-4-9C	1/4" H.P. Female to 9/16" H.P.	53.8	2.12	28.4	1.12	413.7	60,000
6YY6-6-4C	3/8" H.P. Female to 1/4" H.P.	38.1	1.50	25.4	1.00	413.7	60,000
6YY6-6-9C	3/8" H.P. Female to 9/16" H.P.	53.8	2.12	28.4	1.12	413.7	60,000
6YY6-9-4C	9/16" H.P. Female to 1/4" H.P.	44.5	1.75	34.8	1.37	413.7	60,000
6YY6-9-9C	9/16" H.P. Female to 3/8" H.P.	47.5	1.87	34.8	1.37	413.7	60,000

KOVALAN

## 6Y01 – Female high pressure to male NPT

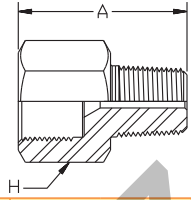



#		A					
		mm	inch	mm	inch	MPa	psi
6Y01-4-2C	1/4" H.P. Female to 1/8" NPT	31.8	1.25	19.1	0.75	103.4	15,000
6Y01-4-4C	1/4" H.P. Female to 1/4" NPT	34.8	1.37	19.1	0.75	103.4	15,000
6Y01-4-6C	1/4" H.P. Female to 3/8" NPT	34.8	1.37	19.1	0.75	103.4	15,000
6Y01-4-8C	1/4" H.P. Female to 1/2" NPT	44.5	1.75	25.4	1.00	103.4	15,000
6Y01-4-12C	1/4" H.P. Female to 3/4" NPT	44.5	1.75	38.4	1.37	68.9	10,000
6Y01-4-16C	1/4" H.P. Female to 1" NPT	41.1	1.62	38.4	1.37	68.9	10,000
6Y01-6-2C	3/8" H.P. Female to 1/8" NPT	38.1	1.50	25.4	1.00	103.4	15,000
6Y01-6-4C	3/8" H.P. Female to 1/4" NPT	41.1	1.62	25.4	1.00	103.4	15,000
6Y01-6-6C	3/8" H.P. Female to 3/8" NPT	41.1	1.62	25.4	1.00	103.4	15,000
6Y01-6-8C	3/8" H.P. Female to 1/2" NPT	44.5	1.75	25.4	1.00	103.4	15,000
6Y01-6-12C	3/8" H.P. Female to 3/4" NPT	47.5	1.87	38.4	1.37	68.9	10,000
6Y01-6-16C	3/8" H.P. Female to 1" NPT	47.5	1.87	38.4	1.37	68.9	10,000
6Y01-9-2C	9/16" H.P. Female to 1/8" NPT	38.1	1.50	38.4	1.37	103.4	15,000
6Y01-9-4C	9/16" H.P. Female to 1/4" NPT	41.1	1.62	32.3	1.27	103.4	15,000
6Y01-9-6C	9/16" H.P. Female to 3/8" NPT	44.5	1.75	38.4	1.37	103.4	15,000
6Y01-9-8C	9/16" H.P. Female to 1/2" NPT	47.5	1.87	38.4	1.37	103.4	15,000
6Y01-9-12C	9/16" H.P. Female to 3/4" NPT	47.5	1.87	38.4	1.37	68.9	10,000
6Y01-9-16C	9/16" H.P. Female to 1" NPT	50.8	2.00	38.4	1.37	68.9	10,000

Adapters & Valves



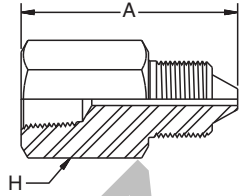

## 02Y6 – Female NPT to male high pressure



#		A		H		MPa	psi
		mm	inch	mm	inch		
02Y6-2-4C	1/8" NPT to 1/4" H.P.	41.1	1.62	19.1	0.75	103.4	15,000
02Y6-2-6C	1/8" NPT to 3/8" H.P.	41.1	1.62	19.1	0.75	103.4	15,000
02Y6-2-9C	1/8" NPT to 9/16" H.P.	53.8	2.12	28.4	1.12	103.4	15,000
02Y6-4-4C	1/4" NPT to 1/4" H.P.	44.5	1.75	19.1	0.75	103.4	15,000
02Y6-4-6C	1/4" NPT to 3/8" H.P.	44.5	1.75	19.1	0.75	103.4	15,000
02Y6-4-9C	1/4" NPT to 9/16" H.P.	53.8	2.12	28.4	1.12	103.4	15,000
02Y6-6-4C	3/8" NPT to 1/4" H.P.	44.5	1.75	25.4	1.00	103.4	15,000
02Y6-6-6C	3/8" NPT to 3/8" H.P.	44.5	1.75	25.4	1.00	103.4	15,000
02Y6-6-9C	3/8" NPT to 9/16" H.P.	53.8	2.12	28.4	1.12	103.4	15,000
02Y6-8-4C	1/2" NPT to 1/4" H.P.	53.8	2.12	28.4	1.12	103.4	15,000
02Y6-8-6C	1/2" NPT to 3/8" H.P.	53.8	2.12	28.4	1.12	103.4	15,000
02Y6-8-9C	1/2" NPT to 9/16" H.P.	53.8	2.12	28.4	1.12	103.4	15,000
02Y6-12-6C	3/4" NPT to 3/8" H.P.	38.1	1.50	41.1	1.62	68.9	10,000
02Y6-12-9C	3/4" NPT to 9/16" H.P.	57.2	2.25	34.8	1.37	68.9	10,000
02Y6-16-9C	1" NPT to 9/16" H.P.	50.8	2.0	69.9	2.75	68.9	10,000

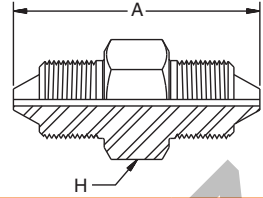

## Y6Y6 – Male high pressure to male high pressure

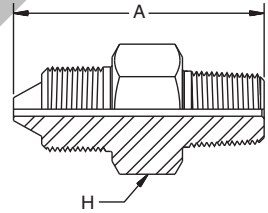

#		A		H			
		mm	inch	mm	inch	MPa	psi
Y6Y6-4-4C	1/4" H.P. to 1/4" H.P.	42.7	1.68	15.7	0.62	413.7	60,000
Y6Y6-4-6C	1/4" H.P. to 3/8" H.P.	52.3	2.06	19.1	0.75	413.7	60,000
Y6Y6-4-9C	1/4" H.P. to 9/16" H.P.	57.2	2.25	28.4	1.12	413.7	60,000
Y6Y6-6-6C	3/8" H.P. to 3/8" H.P.	57.2	2.25	19.1	0.75	413.7	60,000
Y6Y6-6-9C	3/8" H.P. to 9/16" H.P.	63.5	2.50	28.4	1.12	413.7	60,000
Y6Y6-9-9C	9/16" H.P. to 9/16" H.P.	66.5	2.62	28.4	1.12	413.7	60,000

## Y601 – Male high pressure to male NPT



#		A		H			
		mm	inch	mm	inch	MPa	psi
Y601-4-2C	1/4" H.P. to 1/8" NPT	47.5	1.87	15.7	0.62	103.4	15,000
Y601-4-4C	1/4" H.P. to 1/4" NPT	52.3	2.06	19.1	0.75	103.4	15,000
Y601-4-6C	1/4" H.P. to 3/8" NPT	50.8	2.00	19.1	0.75	103.4	15,000
Y601-4-8C	1/4" H.P. to 1/2" NPT	53.8	2.12	22.1	0.87	103.4	15,000
Y601-4-12C	1/4" H.P. to 3/4" NPT	57.2	2.25	28.4	1.12	68.9	10,000
Y601-6-4C	1/4" H.P. to 1" NPT	53.8	2.12	22.1	0.87	103.4	15,000
Y601-6-6C	3/8" H.P. to 1/8" NPT	53.8	2.12	22.1	0.87	103.4	15,000
Y601-9-4C	3/8" H.P. to 1/4" NPT	60.2	2.37	28.4	1.12	103.4	15,000
Y601-9-6C	3/8" H.P. to 3/8" NPT	60.2	2.37	28.4	1.12	103.4	15,000
Y601-9-8C	3/8" H.P. to 1/2" NPT	63.5	2.50	28.4	1.12	103.4	15,000
Y601-9-12C	3/8" H.P. to 3/4" NPT	66.5	2.62	28.4	1.12	68.9	10,000
Y601-9-16C	3/8" H.P. to 1" NPT	69.9	2.75	34.8	1.37	68.9	10,000

### 6Y6Y – Straight coupling

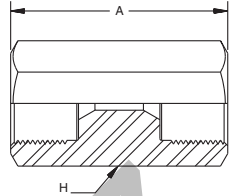

#		A		H			
		mm	inch	mm	inch	MPa	psi
6Y6Y-4-4C	1/4" H.P.	44.5	1.75	25.4	1.00	413.7	60,000
6Y6Y-6-6C	3/8" H.P.	50.8	2.00	25.4	1.00	413.7	60,000
6Y6Y-9-9C	9/16" H.P.	60.2	2.37	34.8	1.37	413.7	60,000

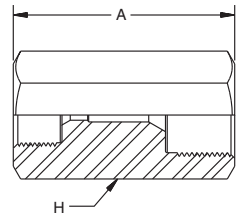

### 6Y6Y – Reducer coupling

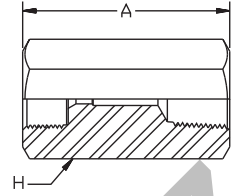

#		A		H			
		mm	inch	mm	inch	MPa	psi
6Y6Y-4-6C	1/4" H.P. to 3/8" H.P.	41.1	1.62	25.4	1.00	413.7	60,000
6Y6Y-4-9C	1/4" H.P. to 9/16" H.P.	44.5	1.75	34.8	1.37	413.7	60,000
6Y6Y-6-9C	3/8" H.P. to 9/16" H.P.	50.8	2.00	34.8	1.37	413.7	60,000

## 6Y02 – Female high pressure to female NPT coupling







#		A					
		mm	inch	mm	inch	MPa	psi
6Y02-4-2C	1/4" H.P. to 1/8" NPT	38.1	1.50	25.4	1.00	103.4	15,000
6Y02-4-4C	1/4" H.P. to 1/4" NPT	38.1	1.50	25.4	1.00	103.4	15,000
6Y02-4-6C	1/4" H.P. to 3/8" NPT	47.5	1.87	25.4	1.00	103.4	15,000
6Y02-4-8C	1/4" H.P. to 1/2" NPT	47.5	1.87	28.4	1.12	103.4	15,000
6Y02-4-12C	1/4" H.P. to 3/4" NPT	50.8	2.00	41.1	1.62	68.9	10,000
6Y02-4-16C	1/4" H.P. to 1" NPT	63.5	2.50	44.5	1.75	68.9	10,000
6Y02-6-2C	3/8" H.P. to 1/8" NPT	47.5	1.87	25.4	1.00	103.4	15,000
6Y02-6-4C	3/8" H.P. to 1/4" NPT	47.5	1.87	25.4	1.00	103.4	15,000
6Y02-6-6C	3/8" H.P. to 3/8" NPT	47.5	1.87	25.4	1.00	103.4	15,000
6Y02-6-8C	3/8" H.P. to 1/2" NPT	47.5	1.87	28.4	1.12	103.4	15,000
6Y02-6-12C	3/8" H.P. to 3/4" NPT	53.8	2.12	34.8	1.37	68.9	10,000
6Y02-6-16C	3/8" H.P. to 1" NPT	63.5	2.50	44.5	1.75	68.9	10,000
6Y02-9-2C	9/16" H.P. to 1/8" NPT	60.2	2.37	34.8	1.37	103.4	15,000
6Y02-9-4C	9/16" H.P. to 1/4" NPT	60.2	2.37	34.8	1.37	103.4	15,000
6Y02-9-6C	9/16" H.P. to 3/8" NPT	60.2	2.37	34.8	1.37	103.4	15,000
6Y02-9-8C	9/16" H.P. to 1/2" NPT	60.2	2.37	34.8	1.37	103.4	15,000
6Y02-9-12C	9/16" H.P. to 3/4" NPT	60.2	2.37	34.8	1.37	68.9	10,000
6Y02-9-16C	9/16" H.P. to 1" NPT	66.5	2.62	50.8	2.00	68.9	10,000



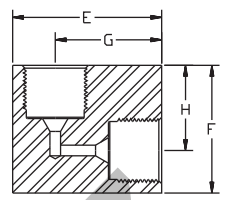





**L6Y – High pressure elbow**

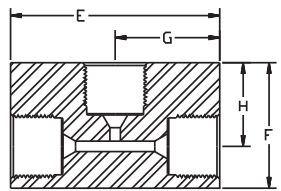

#				E		F		G		H			
		mm	inch	mm	inch	mm	inch	mm	inch	mm	inch	MPa	psi
L6Y-4C	1/4" H.P.	25.4	1.00	34.8	1.37	38.1	1.50	22.1	0.87	25.4	1.00	413.7	60,000
L6Y-6C	3/8" H.P.	25.4	1.00	44.5	1.75	38.1	1.50	31.8	1.25	25.4	1.00	413.7	60,000
L6Y-9C	9/16" H.P.	38.1	1.50	66.5	2.62	47.5	1.87	28.4	1.12	28.4	1.12	413.7	60,000



**T6Y – High pressure tee**

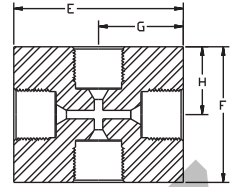

#				E		F		G		H			
		mm	inch	mm	inch	mm	inch	mm	inch	mm	inch	MPa	psi
T6Y-4C	1/4" H.P.	25.4	1.00	34.8	1.37	34.8	1.37	25.4	1.00	22.1	0.87	413.7	60,000
T6Y-6C	3/8" H.P.	25.4	1.00	44.5	1.75	39.6	1.56	25.4	1.00	26.9	1.06	413.7	60,000
T6Y-9C	9/16" H.P.	38.1	1.50	66.5	2.62	53.8	2.12	41.1	1.62	34.8	1.37	413.7	60,000

## X6Y – High pressure cross

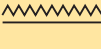



#				E		F		G		H			
		mm	inch	mm	inch	mm	inch	mm	inch	mm	inch	MPa	psi
X6Y-4C	1/4" H.P.	25.4	1.00	50.8	2.00	38.1	1.50	25.4	1.00	19.1	0.75	413.7	60,000
X6Y-6C	3/8" H.P.	25.4	1.00	53.8	2.12	50.8	2.00	26.9	1.06	25.4	1.00	413.7	60,000
X6Y-9C	9/16" H.P.	38.1	1.50	69.9	2.75	66.5	2.62	34.8	1.37	33.3	1.31	413.7	60,000

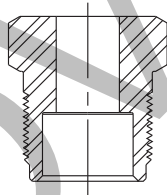

## Y4N – High pressure gland nut

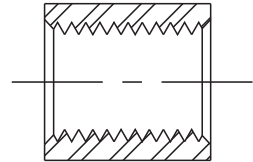



## Y4C – High pressure collar



#			
		MPa	psi
Y4N-4C	1/4" H.P.	413.7	60,000
Y4N-6C	3/8" H.P.	413.7	60,000
Y4N-9C	9/16" H.P.	413.7	60,000



#			
		MPa	psi
Y4C-4C	1/4" H.P.	413.7	60,000
Y4C-6C	3/8" H.P.	413.7	60,000
Y4C-9C	9/16" H.P.	413.7	60,000

### HBPHM – High pressure plug

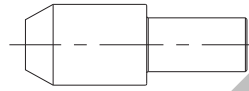
#			
		MPa	psi
HBPHM4-B	1/4" H.P.	413.7	60,000
HBPHM6-B	3/8" H.P.	413.7	60,000
HBPHM9-B	9/16" H.P.	413.7	60,000



### Locking nut/collar – Anti-vibration

#					
		mm	inch	MPa	psi
Y4NC-4C-AV	1/4" H.P.	17.3	0.68	16.0	0.63
Y4NC-6C-AV	3/8" H.P.	26.9	1.06	17.3	0.68
Y4NC-9C-AV	9/16" H.P.	39.6	1.56	42.7	1.68

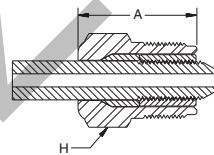

### Nipples – High pressure



Length		#	#	#
mm	inch			
69.9	2.75	Y404-0275C	–	Y409-0275C
76.2	3.00	Y404-0300C	Y406-0300C	–
101.6	4.00	Y404-0400C	–	Y409-0400C
152.4	6.00	Y404-0600C	Y406-0600C	Y409-0600C
203.2	8.00	Y404-0800C	Y406-0800C	Y409-0800C
254.0	10.00	Y404-1000C	Y406-1000C	Y409-1000C
304.8	12.00	Y404-1200C	Y406-1200C	Y409-1200C

## National Pipe Tapered (NPT)

### Features

---



- An industry standard for use at elevated pressures.
- Suitable for repetitive assembly and disassembly.

### Construction

---

**polyflex™** offers a broad range of high quality stainless steel high pressure NPT adapters.

Sizes 1/8" to 1/2" are rated up to 15,000 psi, 3/4" and above are rated to 10,000 psi.

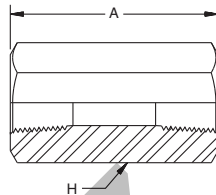

### K0202 – NPT coupler

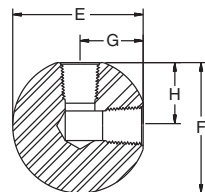

#		A		H			
		mm	inch	mm	inch	MPa	psi
15K0202-2-2C	1/8" NPT Female	38.1	1.50	19.1	0.75	103.4	15,000
15K0202-4-4C	1/4" NPT Female	44.5	1.75	22.1	0.87	103.4	15,000
15K0202-6-6C	3/8" NPT Female	44.5	1.75	25.4	1.00	103.4	15,000
15K0202-8-8C	1/2" NPT Female	54.1	2.13	31.8	1.25	103.4	15,000
10K0202-12-12C	3/4" NPT Female	54.1	2.13	38.1	1.50	68.9	10,000
10K0202-16-16C	1" NPT Female	63.5	2.50	50.8	2.00	68.9	10,000

### KL02 – NPT elbow





#				E		F		G		H			
		mm	inch	mm	inch	mm	inch	mm	inch	mm	inch	MPa	psi
15KL02-4C	1/4" NPT Female	29.1	1.15	43.2	1.70	43.2	1.70	20.3	0.80	20.3	0.80	103.4	15,000
15KL02-6C	3/8" NPT Female	35.1	1.38	48.3	1.90	48.3	1.90	22.9	0.90	22.9	0.90	103.4	15,000
15KL02-8C	1/2" NPT Female	41.4	1.63	54.6	2.15	54.6	2.15	26.2	1.03	26.2	1.03	103.4	15,000
10KL02-12C	3/4" NPT Female	52.1	2.05	47.0	1.85	47.0	1.85	34.3	1.35	34.3	1.35	68.9	10,000
10KL02-16C	1" NPT Female	63.5	2.50	97.3	3.83	97.3	3.83	46.2	1.82	46.2	1.82	68.9	10,000

Adapters & Valves

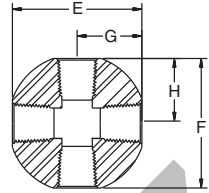

## KX02 – NPT cross



#				E		F		G		H			
		mm	inch	mm	inch	mm	inch	mm	inch	mm	inch	MPa	psi
15KX02-4C	1/4" NPT Female	29.2	1.15	40.6	1.60	40.6	1.60	20.3	0.80	20.3	0.80	103.4	15,000
15KX02-6C	3/8" NPT Female	35.1	1.38	45.7	1.80	45.7	1.80	22.9	0.90	22.9	0.90	103.4	15,000
15KX02-8C	1/2" NPT Female	41.4	1.63	52.1	2.05	52.1	2.05	26.2	1.03	26.2	1.03	103.4	15,000
10KX02-12C	3/4" NPT Female	52.1	2.05	68.6	2.70	68.6	2.70	34.3	1.35	34.3	1.35	68.9	10,000
10KX02-16C	1" NPT Female	63.5	2.50	92.2	3.63	92.2	3.63	46.2	1.82	46.2	1.82	68.9	10,000

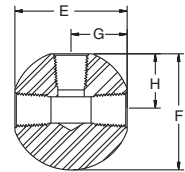

## KT02 – NPT tee



#				E		F		G		H			
		mm	inch	mm	inch	mm	inch	mm	inch	mm	inch	MPa	psi
15KT02-4C	1/4" NPT Female	29.2	1.15	40.6	1.60	43.2	1.70	20.3	0.80	29.2	1.15	103.4	15,000
15KT02-6C	3/8" NPT Female	35.1	1.38	45.7	1.80	48.3	1.90	22.9	0.90	35.1	1.38	103.4	15,000
15KT02-8C	1/2" NPT Female	41.4	1.63	52.1	2.05	54.6	2.15	26.2	1.03	41.4	1.63	103.4	15,000
10KT02-12C	3/4" NPT Female	52.1	2.05	68.6	2.70	47.0	1.85	34.3	1.35	52.1	2.05	68.9	10,000
10KT02-16C	1" NPT Female	63.5	2.50	92.2	3.63	97.3	3.83	46.2	1.82	65.3	2.50	68.9	10,000

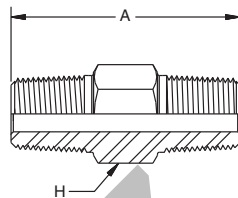

### K0101 – NPT nipple

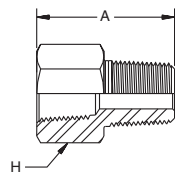

#		A		H			
		mm	inch	mm	inch	MPa	psi
15K0101-1-1C	1/16" NPT Male	25.4	1.00	9.7	0.38	103.4	15,000
15K0101-2-2C	1/8" NPT Male	30.5	1.20	12.7	0.50	103.4	15,000
15K0101-4-4C	1/4" NPT Male	36.6	1.44	16.0	0.63	103.4	15,000
15K0101-6-6C	3/8" NPT Male	43.2	1.70	19.1	0.75	103.4	15,000
15K0101-8-8C	1/2" NPT Male	57.2	2.25	25.4	1.00	103.4	15,000
10K0101-12-12C	3/4" NPT Male	62.0	2.44	28.7	1.13	68.9	10,000
10K0101-16-16C	1" NPT Male	69.9	2.75	35.1	1.38	68.9	10,000

### K0201 – NPT reducer bushing



#		A		H			
		mm	inch	mm	inch	MPa	psi
15K0201-1-8C	1/16" NPT Female to 1/2" NPT Male	31.8	1.25	22.1	0.87	103.4	15,000
15K0201-2-8C	1/8" NPT Female to 1/2" NPT Male	31.8	1.25	22.1	0.87	103.4	15,000
15K0201-4-8C	1/4" NPT Female to 1/2" NPT Male	31.8	1.25	22.1	0.87	103.4	15,000
15K0201-6-8C	3/8" NPT Female to 1/2" NPT Male	41.4	1.63	25.4	1.00	103.4	15,000

Adapters & Valves

## Valves

Medium Pressure – Up to 20,000 psi

High Pressure – Up to 60,000 psi

### Scope

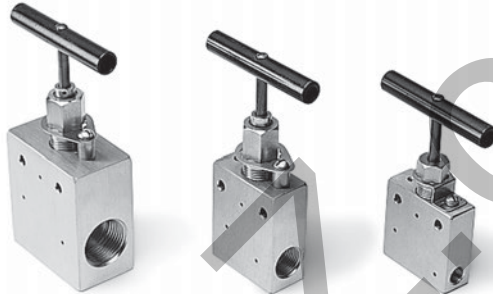

Developed to assure safe and easy plumbing through 60,000 psi. These needle valves are engineered to the highest standards of repeatable quality. The medium pressure valves are designed with a compact cone-and-threaded connection which permits the larger bore sizes and increased flow rates common in this pressure class. The high pressure valves also use a coned-and-threaded connection which accommodates the high pressures common in these applications.

Non-rotating tip stems are standard for on-off service and insure long life on valve seats.

Materials include high tensile type 316 stainless steel bodies and hardened 17-4PH stainless steel lower section stems.

Packing is TFE standard with optional Viton®, BUNA-N and Grafoil available as non-standard.

Two Way Straight valves are standard with five additional patterns to satisfy widely varied requirements are available on request.

### Features

- Non-Rotating Stem Tips
- Packing Below Stem Threads
- Type 316 ss high tensile bodies
- Positive gland lock device
- No stem adjustment needed
- Black T-handles standard or choice of 4 colors (special order)
- Tube sizes

Medium Pressure – 1/4" through 1"

High Pressure – 1/4" through 9/16"



**SV5Y – Two way straight valves**  
**Medium Pressure (M.P.) – 20,000 psi**

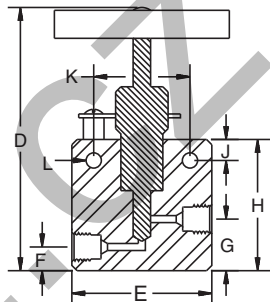

#		Orifice					
		mm	inch	mm	inch	MPa	psi
SV5Y-4C-20	1/4" M.P.	2.5	0.10	19.1	0.75	137.9	20,000
SV5Y-6C-20	3/8" M.P.	5.1	0.20	19.1	0.75	137.9	20,000
SV5Y-9C-20	9/16" M.P.	7.9	0.31	25.4	1.00	137.9	20,000
SV5Y-12C-20	3/4 M.P.	13.0	0.51	34.8	1.37	137.9	20,000
SV5Y-16C-20	1" M.P.	17.3	0.68	44.5	1.75	137.9	20,000



#	D		E		F		G		H		J		K		L	
	mm	inch	mm	inch	mm	inch	mm	inch	mm	inch	mm	inch	mm	inch	mm	inch
SV5Y-4C-20	111.0	4.37	50.8	2.00	9.4	0.37	20.6	0.81	50.8	2.00	9.4	0.37	31.8	1.25	5.3	0.21
SV5Y-6C-20	111.0	4.37	50.8	2.00	9.4	0.37	20.6	0.81	50.8	2.00	9.4	0.37	31.8	1.25	5.3	0.21
SV5Y-9C-20	155.4	6.12	63.5	2.50	12.7	0.50	28.4	1.12	72.9	2.87	12.7	0.50	34.8	1.37	8.6	0.34
SV5Y-12C-20	177.8	7.00	76.2	3.00	19.1	0.75	38.1	1.50	95.3	3.75	15.7	0.62	44.5	1.75	10.9	0.43
SV5Y-16C-20	213.9	8.42	106.6	4.12	22.1	0.87	46.0	1.81	117.3	4.62	28.4	1.12	63.5	2.50	14.2	0.56

Adapters & Valves

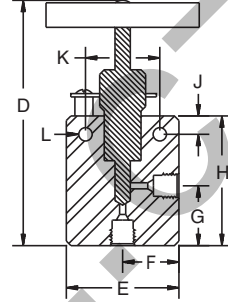

## AV5Y – Two way angle valves Medium Pressure (M.P.) – 20,000 psi

#		Orifice					
		mm	inch	mm	inch	MPa	psi
AV5Y-4C-20	1/4" M.P.	2.5	0.10	19.1	0.75	137.9	20,000
AV5Y-6C-20	3/8" M.P.	5.1	0.20	19.1	0.75	137.9	20,000
AV5Y-9C-20	9/16" M.P.	7.9	0.31	25.4	1.00	137.9	20,000
AV5Y-12C-20	3/4 M.P.	13.0	0.51	34.8	1.37	137.9	20,000
AV5Y-16C-20	1" M.P.	17.3	0.68	44.5	1.75	137.9	20,000



#	D		E		F		G		H		J		K		L	
	mm	inch	mm	inch	mm	inch	mm	inch	mm	inch	mm	inch	mm	inch	mm	inch
AV5Y-4C-20	122.2	4.81	50.8	2.00	25.4	1.00	31.8	1.25	61.7	2.43	9.4	0.37	31.8	1.25	5.3	0.21
AV5Y-6C-20	122.2	4.81	50.8	2.00	25.4	1.00	31.8	1.25	61.7	2.43	9.4	0.37	31.8	1.25	5.3	0.21
AV5Y-9C-20	168.1	6.62	63.5	2.50	31.8	1.25	41.1	1.62	85.6	3.37	12.7	0.50	34.8	1.37	8.6	0.34
AV5Y-12C-20	190.5	7.50	76.2	3.00	38.1	1.50	50.8	2.00	108.0	4.25	15.7	0.62	44.5	1.75	10.9	0.43
AV5Y-16C-20	236.5	9.37	104.6	4.12	52.3	2.06	65.0	2.56	137.9	5.43	28.4	1.12	63.5	2.50	14.2	0.56

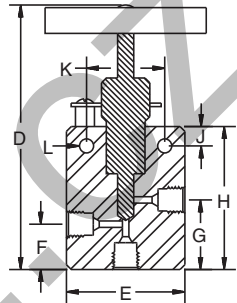

**TV25Y – Three way valves**  
**Medium Pressure (M.P.) – 20,000 psi**  
**Two pressure connections**

#		Orifice					
		mm	inch	mm	inch	MPa	psi
TV25Y-4C-20	1/4" M.P.	2.5	0.10	19.1	0.75	137.9	20,000
TV25Y-6C-20	3/8" M.P.	5.1	0.20	19.1	0.75	137.9	20,000
TV25Y-9C-20	9/16" M.P.	7.9	0.31	25.4	1.00	137.9	20,000
TV25Y-12C-20	3/4 M.P.	13.0	0.51	34.8	1.37	137.9	20,000
TV25Y-16C-20	1" M.P.	17.3	0.68	44.5	1.75	137.9	20,000



#	D		E		F		G		H		J		K		L	
	mm	inch	mm	inch	mm	inch	mm	inch	mm	inch	mm	inch	mm	inch	mm	inch
TV25Y-4C-20	127.0	5.00	50.8	2.00	25.4	1.00	36.3	1.43	66.5	2.62	9.4	0.37	31.8	1.25	5.3	0.21
TV25Y-6C-20	127.0	5.00	50.8	2.00	25.4	1.00	36.3	1.43	66.5	2.62	9.4	0.37	31.8	1.25	5.3	0.21
TV25Y-9C-20	174.5	6.87	63.5	2.50	31.8	1.25	47.5	1.87	91.9	3.62	12.7	0.50	34.8	1.37	8.6	0.34
TV25Y-12C-20	199.9	7.87	76.2	3.00	66.5	2.62	60.2	2.37	117.3	4.62	15.7	0.62	44.5	1.75	10.9	0.43
TV25Y-16C-20	247.7	9.75	104.6	4.12	53.8	2.12	77.7	3.06	149.1	5.87	28.4	1.12	63.5	2.50	14.2	0.56

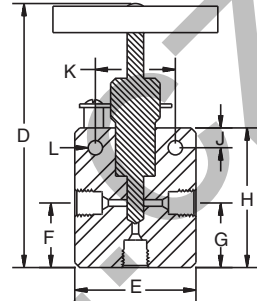

**TV15Y – Three way valves**  
**Medium Pressure (M.P.) – 20,000 psi**  
**One pressure connection**

#		Orifice					
		mm	inch	mm	inch	MPa	psi
TV15Y-4C-20	1/4" M.P.	2.5	0.10	19.1	0.75	137.9	20,000
TV15Y-6C-20	3/8" M.P.	5.1	0.20	19.1	0.75	137.9	20,000
TV15Y-9C-20	9/16" M.P.	7.9	0.31	25.4	1.00	137.9	20,000
TV15Y-12C-20	3/4 M.P.	13.0	0.51	34.8	1.37	137.9	20,000
TV15Y-16C-20	1" M.P.	17.3	0.68	44.5	1.75	137.9	20,000



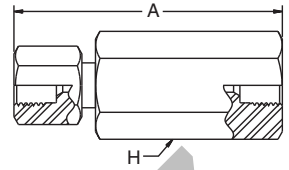

#	D		E		F		G		H		J		K		L	
	mm	inch	mm	inch	mm	inch	mm	inch	mm	inch	mm	inch	mm	inch	mm	inch
TV15Y-4C-20	122.2	4.81	50.8	2.00	31.8	1.25	31.8	1.25	61.7	2.43	9.4	0.37	31.8	1.25	5.3	0.21
TV15Y-6C-20	122.2	4.81	50.8	2.00	31.8	1.25	31.8	1.25	61.7	2.43	9.4	0.37	31.8	1.25	5.3	0.21
TV15Y-9C-20	168.1	6.62	63.5	2.50	41.1	1.62	41.1	1.62	85.6	3.37	12.7	0.50	34.8	1.37	8.6	0.34
TV15Y-12C-20	190.5	7.50	76.2	3.00	50.8	2.00	50.8	2.00	108.0	4.25	15.7	0.62	44.5	1.75	10.9	0.43
TV15Y-16C-20	236.5	9.37	104.6	4.12	52.3	2.62	52.3	2.62	137.9	5.43	28.4	1.12	63.5	2.50	14.2	0.56

**CV5Y – Ball check valves**  
Medium Pressure (M.P.) – 20,000 psi

#		Orifice					
		mm	inch	mm	inch	MPa	psi
CV5Y-4C-20	1/4" M.P.	95.3	3.75	25.4	1.00	137.9	20,000
CV5Y-6C-20	3/8" M.P.	95.3	3.75	25.4	1.00	137.9	20,000
CV5Y-9C-20	9/16" M.P.	110.5	4.35	34.8	1.37	137.7	20,000

## SV6Y – Two way straight valves

High Pressure (H.P.) – 30,000 psi

#		Orifice					
		mm	inch	mm	inch	MPa	psi
SV6Y-4C-30	1/4" H.P.	2.3	0.09	25.4	1.00	206.8	30,000
SV6Y-6C-30	3/8" H.P.	3.0	0.12	25.4	1.00	206.8	30,000
SV6Y-9C-30	9/16" H.P.	3.0	0.12	38.1	1.50	206.8	30,000

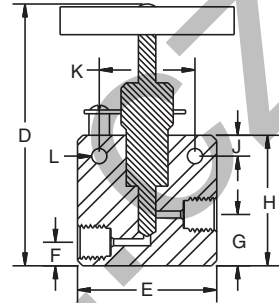

#	D		E		F		G		H		J		K		L	
	mm	inch	mm	inch	mm	inch	mm	inch	mm	inch	mm	inch	mm	inch	mm	inch
SV6Y-4C-30	131.6	5.18	50.8	2.00	15.7	0.62	25.4	1.00	61.7	2.43	12.7	0.50	34.8	1.37	5.3	0.21
SV6Y-6C-30	131.6	5.18	50.8	2.00	15.7	0.62	25.4	1.00	61.7	2.43	12.7	0.50	34.8	1.37	5.3	0.21
SV6Y-9C-30	142.7	5.62	66.5	2.62	25.4	1.00	36.3	1.43	72.9	2.87	12.7	0.50	34.8	1.37	5.3	0.21

## AV6Y – Two way angle valves

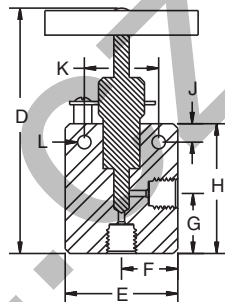

High Pressure (H.P.) – 30,000 psi

#		Orifice				Pressure	
		mm	inch	mm	inch	MPa	psi
AV6Y-4C-30	1/4" H.P.	2.3	0.09	25.4	1.00	206.8	30,000
AV6Y-6C-30	3/8" H.P.	3.0	0.12	25.4	1.00	206.8	30,000
AV6Y-9C-30	9/16" H.P.	3.0	0.12	38.1	1.50	206.8	30,000



#	D		E		F		G		H		J		K		L	
	mm	inch	mm	inch	mm	inch	mm	inch	mm	inch	mm	inch	mm	inch	mm	inch
AV6Y-4C-30	131.6	5.18	50.8	2.00	25.4	1.00	25.4	1.00	61.7	2.43	12.7	0.50	34.8	1.37	5.3	0.21
AV6Y-6C-30	141.2	5.56	50.8	2.00	25.4	1.00	34.8	1.37	71.4	2.81	12.7	0.50	34.8	1.37	5.3	0.21
AV6Y-9C-30	142.7	5.62	66.5	2.62	33.3	1.31	36.3	1.43	72.9	2.87	12.7	0.50	34.8	1.37	5.3	0.21

**TV26Y – Three way valves**  
High Pressure (H.P.) – 30,000 psi  
Two pressure connections

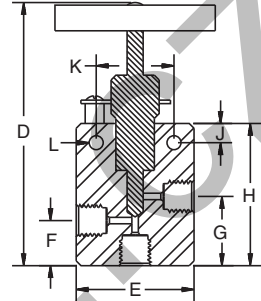

#		Orifice					
		mm	inch	mm	inch	MPa	psi
TV26Y-4C-30	1/4" H.P.	2.3	0.09	25.4	1.00	206.8	30,000
TV26Y-6C-30	3/8" H.P.	3.0	0.12	25.4	1.00	206.8	30,000
TV26Y-9C-30	9/16" H.P.	3.0	0.12	38.1	1.50	206.8	30,000



#	D		E		F		G		H		J		K		L	
	mm	inch	mm	inch	mm	inch	mm	inch	mm	inch	mm	inch	mm	inch	mm	inch
TV26Y-4C-30	131.6	5.18	50.8	2.00	15.7	0.62	25.4	1.00	61.7	2.43	12.7	0.50	34.8	1.37	5.3	0.21
TV26Y-6C-30	141.2	5.56	50.8	2.00	25.4	1.00	34.8	1.37	71.4	2.81	12.7	0.50	34.8	1.37	5.3	0.21
TV26Y-9C-30	153.9	6.06	66.5	2.62	36.3	1.43	47.5	1.87	84.1	3.31	12.7	0.50	34.8	1.37	5.3	0.21



**TV16Y – Three way valves**  
High Pressure (H.P.) – 30,000 psi  
One pressure connection

#		Orifice					
		mm	inch	mm	inch	MPa	psi
TV16Y-4C-30	1/4" H.P.	2.3	0.09	25.4	1.00	206.8	30,000
TV16Y-6C-30	3/8" H.P.	3.0	0.12	25.4	1.00	206.8	30,000
TV16Y-9C-30	9/16" H.P.	3.0	0.12	38.1	1.50	206.8	30,000

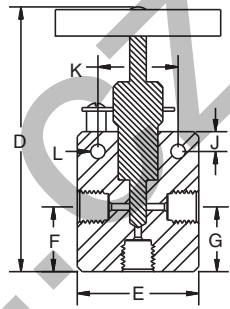



#	D		E		F		G		H		J		K		L	
	mm	inch	mm	inch	mm	inch	mm	inch	mm	inch	mm	inch	mm	inch	mm	inch
TV16Y-4C-30	131.6	5.18	50.8	2.00	25.4	1.00	25.4	1.00	61.7	2.43	12.7	0.50	34.8	1.37	5.3	0.21
TV16Y-6C-30	141.2	5.56	50.8	2.00	50.8	2.00	36.3	1.43	71.4	2.81	12.7	0.50	34.8	1.37	5.3	0.21
TV16Y-9C-30	142.7	5.62	66.5	2.62	55.4	2.18	36.3	1.43	72.9	2.87	12.7	0.50	34.8	1.37	5.3	0.21

Adapters & Valves

## SV6Y – Two way straight valves

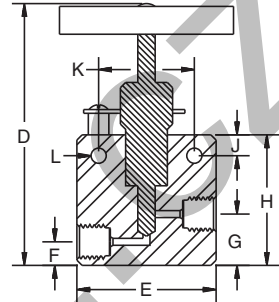

High Pressure (H.P.) – 60,000 psi

#		Orifice					
		mm	inch	mm	inch	MPa	psi
SV6Y-4C-60	1/4" H.P.	1.5	0.06	25.4	1.00	413.7	60,000
SV6Y-6C-60	3/8" H.P.	1.5	0.06	25.4	1.00	413.7	60,000
SV6Y-9C-60	9/16" H.P.	1.5	0.06	38.1	1.50	413.7	60,000



#	D		E		F		G		H		J		K		L	
	mm	inch	mm	inch	mm	inch	mm	inch	mm	inch	mm	inch	mm	inch	mm	inch
SV6Y-4C-60	131.6	5.18	50.8	2.00	15.7	0.62	25.4	1.00	61.7	2.43	12.7	0.50	34.8	1.37	5.3	0.21
SV6Y-6C-60	131.6	5.18	50.8	2.00	15.7	0.62	25.4	1.00	61.7	2.43	12.7	0.50	34.8	1.37	5.3	0.21
SV6Y-9C-60	142.7	5.62	66.5	2.62	25.4	1.00	36.1	1.43	72.9	2.87	12.7	0.50	34.8	1.37	5.3	0.21

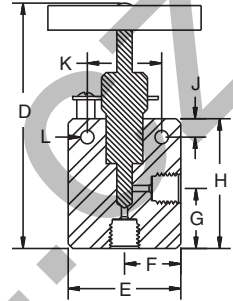

**AV6Y – Two way angle valves**  
**High Pressure (H.P.) – 60,000 psi**

#		Orifice					
		mm	inch	mm	inch	MPa	psi
AV6Y-4C-60	1/4" H.P.	1.5	0.06	25.4	1.00	413.7	60,000
AV6Y-6C-60	3/8" H.P.	1.5	0.06	25.4	1.00	413.7	60,000
AV6Y-9C-60	9/16" H.P.	1.5	0.06	38.1	1.50	413.7	60,000



#	D		E		F		G		H		J		K		L	
	mm	inch	mm	inch	mm	inch	mm	inch	mm	inch	mm	inch	mm	inch	mm	inch
AV6Y-4C-60	131.6	5.18	50.8	2.00	25.4	1.00	25.4	1.00	61.7	2.43	12.7	0.50	34.8	1.37	5.3	0.21
AV6Y-6C-60	141.2	5.56	50.8	2.00	25.4	1.00	34.8	1.37	71.4	2.81	12.7	0.50	34.8	1.37	5.3	0.21
AV6Y-9C-60	141.7	5.62	66.5	2.62	33.3	1.31	36.3	1.43	72.9	2.87	12.7	0.50	34.8	1.37	5.3	0.21

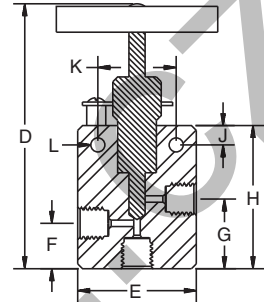

**TV26Y – Three way valves**  
High Pressure (H.P.) – 60,000 psi  
Two pressure connections

#		Orifice					
		mm	inch	mm	inch	MPa	psi
TV26Y-4C-60	1/4" H.P.	1.5	0.06	25.4	1.00	413.7	60,000
TV26Y-6C-60	3/8" H.P.	1.5	0.06	25.4	1.00	413.7	60,000
TV26Y-9C-60	9/16" H.P.	1.5	0.06	38.1	1.50	413.7	60,000



#	D		E		F		G		H		J		K		L	
	mm	inch	mm	inch	mm	inch	mm	inch	mm	inch	mm	inch	mm	inch	mm	inch
TV26Y-4C-60	131.6	5.18	50.8	2.00	15.7	0.62	25.4	1.00	61.7	2.43	12.7	0.50	34.8	1.37	5.3	0.21
TV26Y-6C-60	141.6	5.56	50.8	2.00	25.4	1.00	34.8	1.37	71.4	2.81	12.7	0.50	34.8	1.37	5.3	0.21
TV26Y-9C-60	153.9	6.06	66.5	2.62	36.3	1.43	47.5	1.87	84.1	3.31	12.7	0.50	34.8	1.37	5.3	0.21

**TV16Y – Three way valves**  
**High Pressure (H.P.) – 60,000 psi**  
**One pressure connection**

#		Orifice					
		mm	inch	mm	inch	MPa	psi
TV16Y-4C-60	1/4" H.P.	1.5	0.06	25.4	1.00	413.7	60,000
TV16Y-6C-60	3/8" H.P.	1.5	0.06	25.4	1.00	413.7	60,000
TV16Y-9C-60	9/16" H.P.	1.5	0.06	38.1	1.50	413.7	60,000

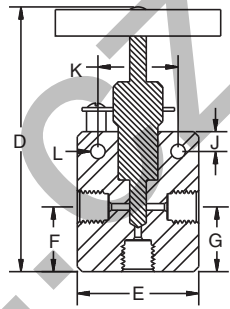



#	D		E		F		G		H		J		K		L	
	mm	inch	mm	inch	mm	inch	mm	inch	mm	inch	mm	inch	mm	inch	mm	inch
TV16Y-4C-60	131.6	5.18	50.8	2.00	25.4	1.00	25.4	1.00	61.7	2.43	12.7	0.50	34.8	1.37	5.3	0.21
TV16Y-6C-60	141.6	5.56	50.8	2.00	50.8	2.00	36.3	1.43	71.4	2.81	12.7	0.50	34.8	1.37	5.3	0.21
TV16Y-9C-60	142.7	5.62	66.5	2.62	55.4	2.18	36.3	1.43	72.9	2.87	12.7	0.50	34.8	1.37	5.3	0.21

Adapters & Valves

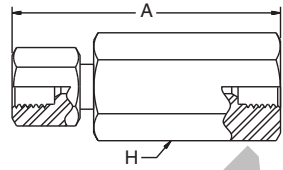
**CV6Y – Ball check valves**  
 High Pressure (H.P.)



#		Orifice					
		mm	inch	mm	inch	MPa	psi
CV6Y-4C-60	1/4" H.P.	106.2	4.18	38.1	1.50	413.7	60,000
CV6Y-6C-60	3/8" H.P.	108.0	4.25	38.1	1.50	413.7	60,000
CV6Y-9C-60	9/16" H.P.	117.3	4.62	39.6	1.56	413.7	60,000

KOVALANIC

---

**Chapter F****Accessories**

Heavy duty abrasion cover .....	F-2
Heavy duty abrasion cover sleeves .....	F-2
Spring guards.....	F-3
Support grips .....	F-3
PVC-S – Anti-abrasion sleeve.....	F-4
HS - Containment grips .....	F-4
UHPLABEL – Precautions for ultra-high pressure applications .....	F-4

KOVANZ

## Heavy duty abrasion cover



#	Description
MHDC010	5/8" I.D. Clear Vinyl
MHDC011	5/8" I.D. Clear Vinyl with white Helix reinforcement
MHDC012	3/4" I.D. Clear Vinyl with white Helix reinforcement
MHDC014	7/8" I.D. Clear Vinyl with white Helix reinforcement
MHDC016	1" I.D. Clear Vinyl with white Helix reinforcement
MHDC018	1-1/8" I.D. Clear Vinyl with white Helix reinforcement
MHDC020	1-1/4" I.D. Clear Vinyl with white Helix reinforcement
MHDC022	1-3/8" I.D. Clear Vinyl with white Helix reinforcement
MHDC024	1-1/2" I.D. Clear Vinyl with white Helix reinforcement
MHDC026	1-5/8" I.D. Clear Vinyl with white Helix reinforcement
MHDC032	2" I.D. Clear Vinyl with white Helix reinforcement

## Heavy duty abrasion cover sleeves



#	Description
508-J-500-10	MHDC010, MHDC011
510-A-500-12	MHDC012
612-400-14	MHDC014
216-200-18	MHDC016, MHDC018
620-100-18	MHDC018 (w/2640N-08 hose)
220-200-22	MHDC022, MHDC024
520-A-500-26	MHDC026



## Spring guards



#	Description
<b>MSG060</b>	0.60" I.D. Continuous Spring
<b>MSG1006</b>	For 2040N-04V00 Hose
<b>MSG2006</b>	For 2245N-04V00 Hose
<b>MSG2106</b>	For 2380N-04v00 Hose
<b>MSG4113</b>	For -8 Hoses
<b>MSG4120</b>	For 2440n-12V37 Hose
<b>MSG4125</b>	For 2440N-16V37 Hose
<b>MSG6020</b>	For 2640N-12v32 Hose

## Support grips

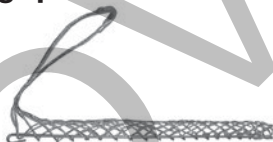

#	Description
<b>MK022-03-038</b>	For Hose O.D. 0.63" - 0.74"
<b>MK022-03-039</b>	For Hose O.D. 0.75" - 0.99"
<b>MK022-03-041</b>	For Hose O.D. 1.00" - 1.24"
<b>MK022-03-042</b>	For Hose O.D. 1.25" - 1.49"
<b>MK022-03-043</b>	For Hose O.D. 1.50" - 1.74"
<b>MK022-03-045</b>	For Hose O.D. 2.25" - 2.49"

## PVC-S - Anti-abrasion sleeve

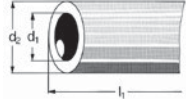

**COLOUR** Yellow

**NOTE** As an alternative, rubber anti-abrasion sleeves are available

#		For hose				Diameter in mm		Hose type	Mountable Length in m
Protective sleeve	Clamp ferrule	DN	size	mm	inch	d1	d2		l1
PVC-S-03	KL-03	5	-03	4.8	3/16	22	28	2640D-03	20/40
PVC-S-05	KL-05	8	-05	7.9	5/16	27	33	2640D-05	20/40
PVC-S-08	KL-08	12	-08	12.7	1/2	35	45	2640N-08	20
PVC-S-12	KL-12	20	-12	19.0	3/4	40	50	2640N-12	20
PVC-S-16	KL-16	25	-16	25.4	1	55	65	2640N-16	20

## HS - Containment grips

**MATERIAL** electrogalvanized steel wire

**NOTE** \*F-KN 3/9: working load 3 KN, breaking load 9 KN, e.g. DN5

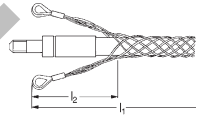

#	For hose						Total Length	Length of Loops in mm
Protective sleeve	DN	size	mm	inch	Ø mm	F-KN*	l1	l2
HS-03	5	-03	4.8	3/16	9-15	3/9	600	200
HS-05	8	-05	7.9	5/16	15-20	6/18	600	200
HS-08	12	-08	12.7	1/2	20-30	11/33	600	200
HS-12	20	-12	19.0	3/4	30-40	11/33	600	200
HS-16	25	-16	25.4	1	40-50	16/48	600	200

## UHPLABEL - Precautions for ultra-high pressure applications

**MATERIAL** self-adhesive PE sticker



#	Dimensions
UHPLABEL	60 x 250 mm

**Chapter G****Technical information**

Installation tips .....	G-2
Selection, installation, and maintenance of polyflex hose and hose assemblies .....	G-3
Dash sizes .....	G-4
Selection of hose diameter from flow rate and velocity .....	G-5
Pressure drop .....	G-6
Glossary .....	G-11
Permeability coefficient .....	G-12
Recommended tightening procedures .....	G-13
Metric conversion chart .....	G-14
General chemical resistance table .....	G-15
Parker Safety Guide .....	G-20

KOVANOV

Technical information

## Installation tips

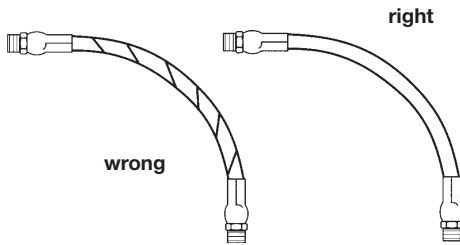

Hose is weakened when installed in twisted position. Also, pressure pulses in twisted hose tend to fatigue wire and loosen fitting connections. Design so that machine motion produces bending rather than torsion.

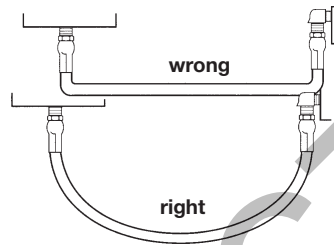

Hose should exit coupling in a straight position rather than side loaded. The minimum bend radius must not be exceeded to avoid kinking of hose and flow restriction.

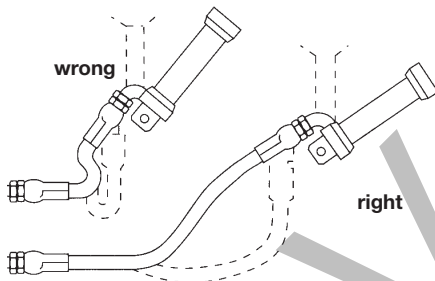

When hose assembly is installed in a flexing application, remember that metal hose fittings are not part of the flexible portion.

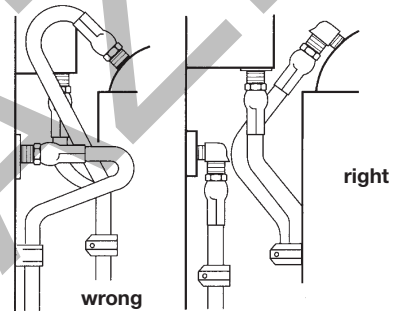

Use elbows or adaptors as necessary to eliminate excess hose length and to ensure neater installation and easier maintenance.

Free hose length allowance:

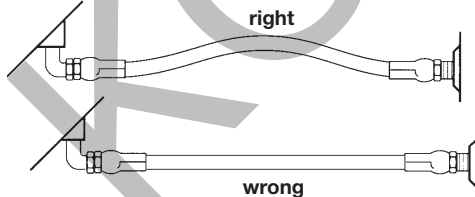

Pressure can change hose in length by as much as  $\pm 2\%$ . This must be considered when cutting hose to appropriate length.

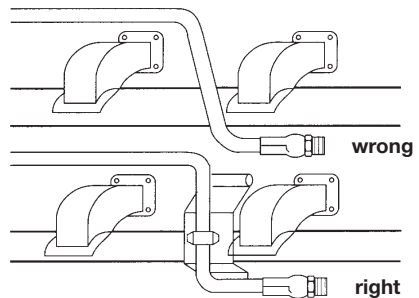

Avoid installing hose assemblies close to heat sources. However, if this should be required, insulate hose.

## Selection, installation, and maintenance of *polyflex* hose and hose assemblies

Hose and hose assemblies have a finite life span and many factors can reduce this time. This recommended practice should be read by designers and users of hose to assist them in the proper selection of hose. These guidelines, while not exhaustive, will assist the user in maintaining hydraulic and pneumatic systems.

**READ THE PARKER SAFETY GUIDE CONTAINED IN THIS CATALOGUE IN ITS ENTIRETY.**

### PART 1 - How to select hose

- **Pressure** - Maximum operating pressure of the hose must be greater than or equal to the system pressure. Pressure surges or system “spikes” in excess of the maximum operating pressure will shorten hose life and must be avoided.
- **Temperature** - Ambient and fluid temperatures must not exceed the hose/fittings rated design temperature. Attempt to route hose or shield hose from high temperature sources.
- **Size** - Adequately size hose and fittings to avoid damaging hose with excessive turbulence, or heat build-up, while maintaining proper flow and pressure. (Refer to fluid velocity nomogram.)
- **Fluid Compatibility** - Refer to Chemical Compatibility Guide in this catalog for use of fluids with various materials. If unsure of an application, contact the factory. Additional care must be taken with gaseous applications.
- **Environment**- Conditions such as ozone, UV light, harsh chemicals, salt water, and other air-borne contaminants can degrade hose and shorten its life.
- **Length** - Hose length changes with pressure. This, along with equipment movement, must be considered in the system design.
- **Proper couplings** - Always follow manufacturers specifications and do not mix components of different manufacturers.
- **Mechanical loads** - Conditions such as tensile and side loads, vibration, excessive flexing, and twist will reduce hose life. Use swivel fittings and adaptors to avoid hose twisting. Test the hose if the application is potentially problematic or unusual.
- **Electrical conductivity** - Determine if the hose must be non-conductive to prevent electrical current flow or conductive to dissipate static electricity. Choose hose and fittings accordingly.

### PART 2 - Installation and maintenance

- **Inspect components** - Check hose for cover cracks, blisters, cleanliness, kinks, cracks or core tube obstructions or other defects. Examine fittings for poor threads, obstructions, cracks, rust. Do not use hose or fittings if these problems exist.
- **Assemble per instructions** - Instructions are available for companies, trained and authorized by Polyflex.
- **Do not exceed specified minimum bend radius** - Use stress relievers to prevent sharp bends at the hose and fitting juncture. These can be spring guards or other stress relieving members.
- **Ensure that hose bends rather than twists with equipment motion.**
- **Use a torque wrench or the flats from finger tight method to properly install port connections.**
- **After installation, eliminate air entrapped in system, pressurise to maximum operating pressure, and check for leaks and proper system function.**
- **After installation, periodically (frequency depends on severity of application and potential risk) inspect the system for the following:**
  1. Blistered, degraded, or loose hose covers.
  2. Stiff, cracked, or charred hose.
  3. Cuts or abrasion of hose. Look for exposed reinforcement.
  4. Leaks in hose or fittings.
  5. Damaged or corroded fittings.
  6. Excessive build up of dirt, grease, oils, etc.
  7. Defective or broken accessories (clamping devices, kink guards)
  8. Kinks in hoses.

Upon discovery of any of these items, replace it, repair it, but **DO NOT IGNORE IT!**

- Retest the system after all maintenance procedures.
- Establish replacement schedules based on previous service life, or when failures could result in damage, personal injury, excessive or unacceptable downtime.

**Dash sizes**

## Dash sizes

Dash sizes are commonly used to designate hose I. D., plastic tubing and metal tubing O. D. and coupling size. Dash size systems in common use:

Nominal hose I.D. or tubing O.D.		Dash number for all <i>polyflex</i> hose	Nominal DN size
Inches	Millimeters		
3/32	2.0	-012	2
1/8	3.2	-2	3
5/32	4.0	-025 or 2A	4
3/16	4.8	-3	5
1/4	6.3	-4	6
5/16	7.9	-5	8
3/8	9.5	-6	10
13/32	10.3	-6.5	-
1/2	12.7	-8	12
5/8	15.9	-10	16
3/4	19.1	-12	20
7/8	22.2	-14	-
1	25.4	-16	25
1-1/8	28.6	-	-
1-1/4	31.8	-20	32
1-3/8	34.9	-	-
1-1/2	38.1	-24	40
1-13/16	46.0	-	-
2	50.8	-32	50

## Selection of hose diameter from flow rate and velocity

**Volumetric flow Q**  
 (l/min) Gal/min\*

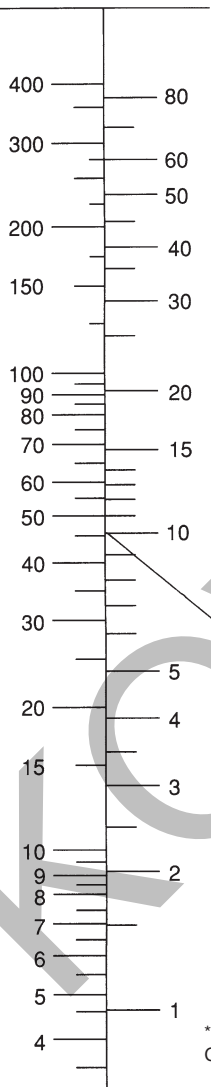

### Flow capacities of Parker hose at recommended flow velocities

The chart below is provided as an aid in the determination of the correct hose size. Suitable for hydraulic applications.

#### Example:

at 10 gallons per minute (gal/min), what is the proper hose size within the recommended velocity range for pressure lines?

Locate 10 gallons per minute in the left-hand column and 25 feet per second in the right-hand column (the maximum recommended velocity range for pressure lines). Lay a straight line across these two points. The inside diameter shown in the centre column is above -6 so we have to use -8 (1/2").

For suction hose, follow the same procedure except use recommended velocity range for intake lines in the right-hand column.

where: Q = flow in gallons per minute (gal/min & l/min)  
 V = velocity in feet per second (f/s & m/s)  
 d = hose inside diameter (mm & dash size)

**Hose inner diameter d**  
 mm dash sizes

50,8	-32
38,1	-24
31,8	-20
25,4	-16
19,1	-12
15,9	-10
12,7	-8
9,5	-6
7,9	-5
6,3	-4
4,8	-3

**Flow velocity v**  
 (m/s) feet/s

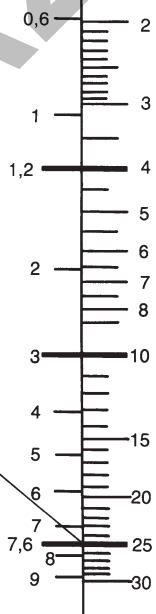

Recommended maximum velocity for suction lines

Recommended maximum velocity for return lines

Recommended maximum velocity for pressure lines

\* gallons are UK gallons

Conversion factors: gal/min x 4.546 = l/min  
 feet/s x 0.3948 = m/s

\* Recommended velocities are according to hydraulic fluids of maximum viscosity 315 S.S.U. at 38 °C working at roomtemperature within 18 ° and 68 °C.

## Pressure drop

### For size -02 (3 mm) hoses

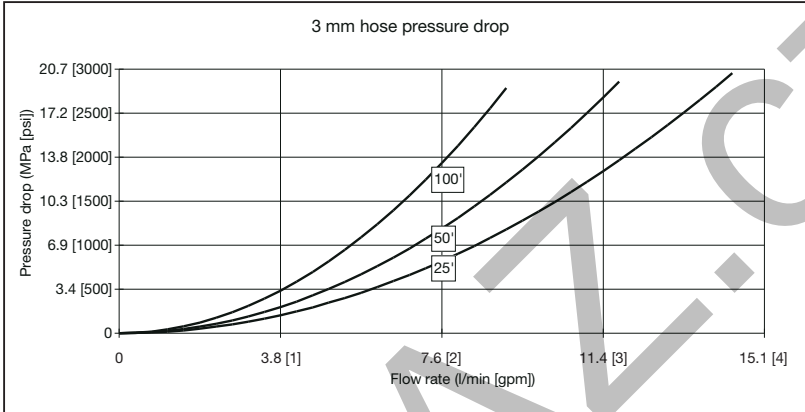

### For size -025 (4 mm) hoses

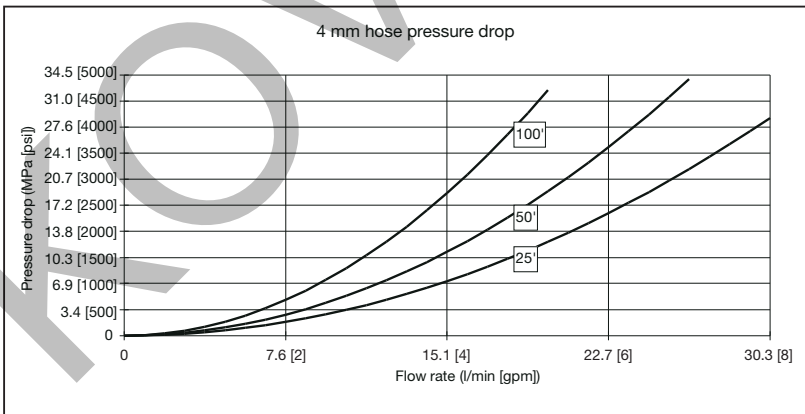

Results obtained from actual pressure drop tests, pumping water through hose assemblies with normal end fittings.

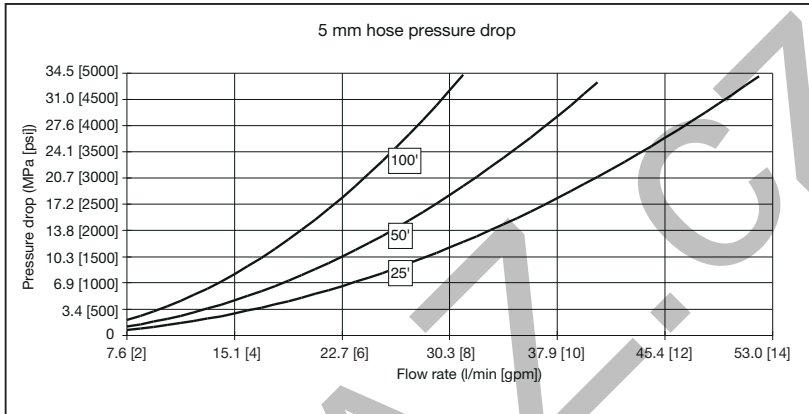
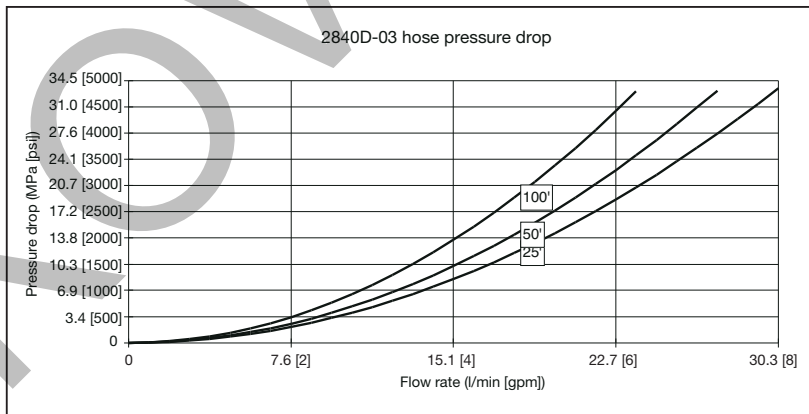

## For size -03 (5 mm) hoses

For Hose:  
2840D-03

Results obtained from actual pressure drop tests, pumping water through hose assemblies with normal end fittings.

**For size -04 (6 mm) hoses**

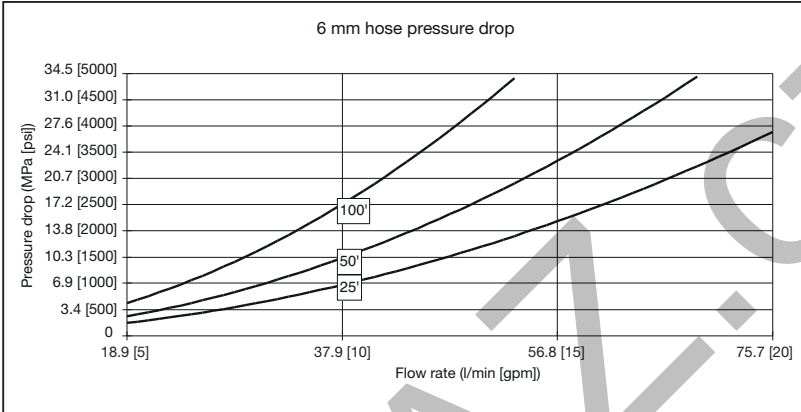

**For size -05 (8 mm) hoses**

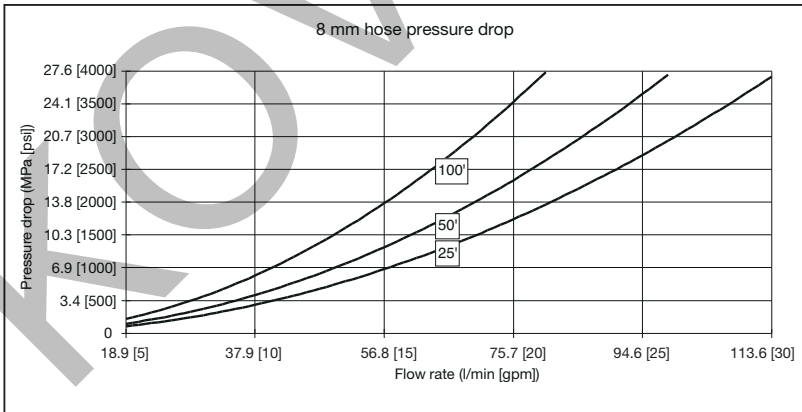

Results obtained from actual pressure drop tests, pumping water through hose assemblies with normal end fittings.

**For size -06 (10 mm) hoses**

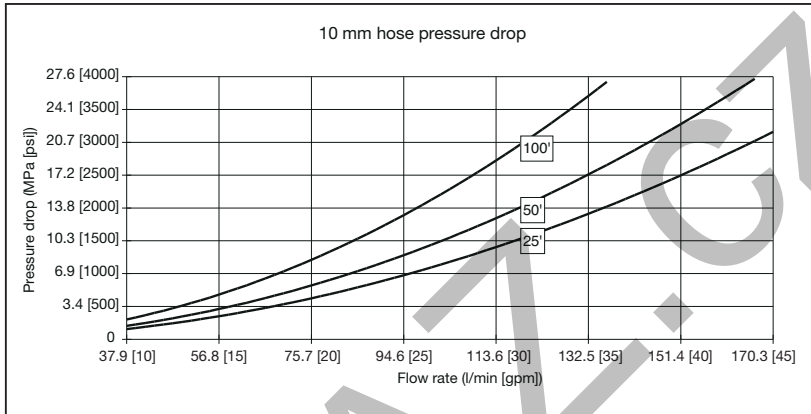

**For size -08 (13 mm) hoses**

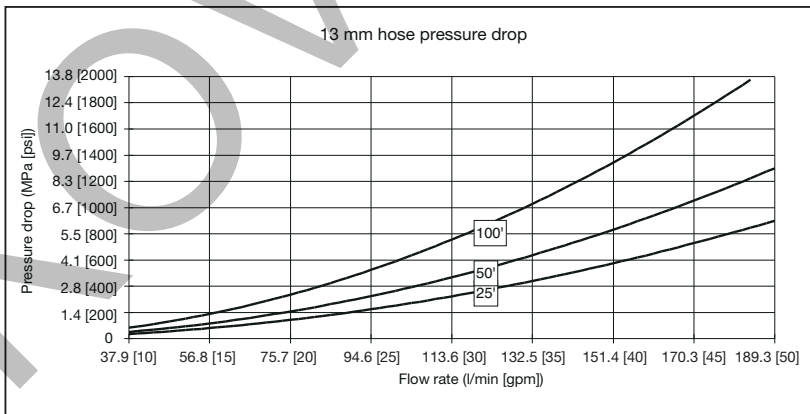

Results obtained from actual pressure drop tests, pumping water through hose assemblies with normal end fittings.

**For size -12 (20 mm) hoses**

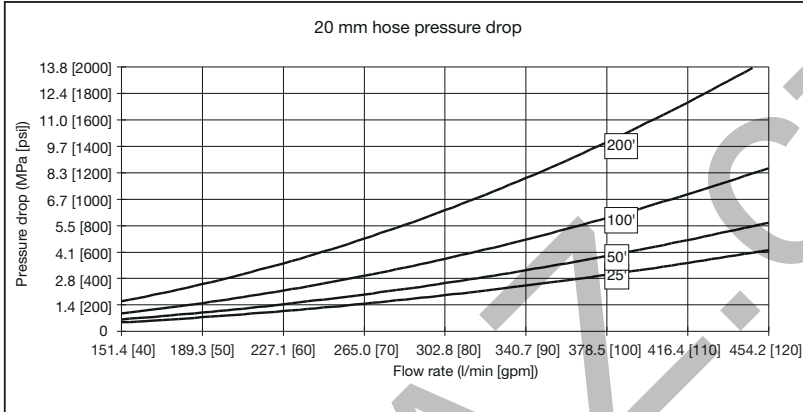

**For size -16 (25 mm) hoses**

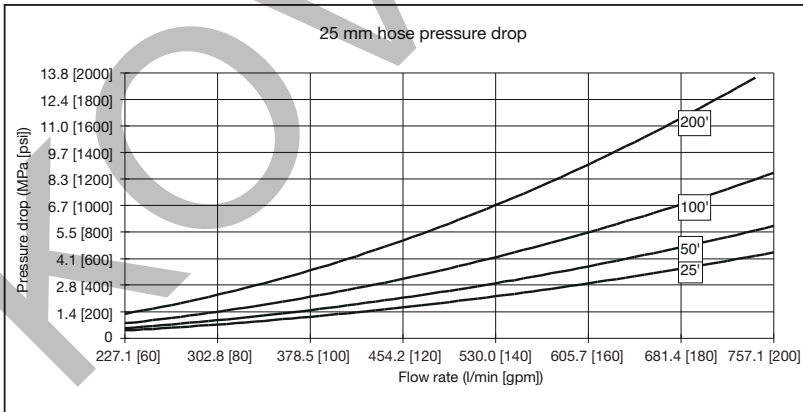

Results obtained from actual pressure drop tests, pumping water through hose assemblies with normal end fittings.

## Glossary

### Abrasion

Abrasion occurs in numerous forms; two of the more common are the typical rubbing or chafing, with the second being very high frequency, low amplitude friction. This type of abrasion results from pump pressure pulses otherwise known as pump ripple. It can also be caused by equipment vibration or resonance. Abrasion may occur when two hose lines cross or when a hose line rubs or bears against a fixed point. Abrasion resistance is also a function of temperature and attack of the cover material by aggressive chemicals. Spring guards or other protective sleeving can also ward off premature hose failure resulting from abrasion. Spring guards also distribute bending force often associated with excessive side loading or even kinking at the skirt of the coupling.

### Ambient temperature

Exceedingly high or low ambient temperatures will affect the materials from which the hose is constructed and will negatively influence hose life. When at all possible, the hose should be routed in such a manner as to protect it from heat sources. In extreme cold applications, the equipment should be designed with remote relief valves to allow circulation and warming of the oil before hose articulation is attempted. The hose liner (core tube) of choice for extremely high or low temperature is Teflon®. Teflon® is serviceable at temperatures as low as -100°F and as high as +450°. Consult the specific hose operating parameters for more information.

### Bend radius

The minimum bend radii listed in this catalog are valid at rated working pressures and indicated service temperatures. Service life of a hose may be shortened if the minimum radius is exceeded or if the hose is flexed continuously in use.

#### Burst pressure and working pressure

The specified burst pressure for each hose style and dash size are for unaged hoses tested at normal laboratory temperature in accordance with SAE J343 specification for normal service and technically ideal installations. The maximum recommended working pressure is 1/4 of the mini-

um rated burst pressure, except as otherwise specifically stated in those product specifications. For more severe service, a higher rated working pressure hose may have to be selected.

### Hose installation tips

Establish hose size (I. D.) and style based upon flow rate (GPM), pressure drop, and chemical compatibility with fluid medium. Other significant factors to be considered in hose selection and installation are discussed briefly as follows:

### Operating temperature

The temperature range for satisfactory service (maximum hose life) depends to a great extent upon the fluid being conveyed. Use of a hose above maximum specified temperature ratings will shorten hose life due, but not limited, to oxidation, chemical degradation and loss of compression within the coupling.

### Pressure effects

Pressure surges and system shocks (spikes) are common in hydraulic systems. The normal 4:1 design factor should reflect these transient pressures. Where these surges and shocks are considered severe or hazardous, the design factor should be increased.

When hose is under pressure, it may change in length by as much as ±3%. Installation should compensate for shortening by providing an appropriate amount of slack and for lengthening by allowing space for this growth to be absorbed.

### Routing and clamping

Whenever possible, and maximum efforts should be made to do so, hose should be routed to flex in a single plane. Routing hoses in flexure through compound bends results in torsions. When this is unavoidable, the torsion should be distributed over the maximum hose length possible. Wire reinforced hoses suffer the most rapid and severe loss of service life when applied in torsion. Extremely tight and improperly located clamps focus this torsion over short distances.

Analysis of the hose function is required before

the proper clamping techniques can be selected. In some applications, hoses must be contained to stay out of harm's way and at the same time be free to come and go with equipment articulation. Other applications may require restrictive clamping, in which case a protective material should be used around the hose to provide the grasp without deformation of the hose by the clamp. These techniques also apply to the use of the popular method of clamping and clustering hoses with plastic tie straps.

Parker swivel adaptors feature 360° swiveling action that especially suits them for use in applications where hose moves, bends or twists. Swivel adapters connected to hose assemblies relieve twisting, prevent excessive flexing of hose, eliminate need for long radius bends, and cushion intraline shock caused by peak system pressure pulses.

#### **High pressure adapters**

It is critical that the adapter material be properly suited to the fluid media. Widely varying conditions frequently necessitate high pressure adapters constructed of materials other than conventional 316 stainless steel. Since many variables affect the corrosion resistance of metallic materials, it is Parker Hannifin's policy not to recommend materials based on corrosion resistance for specific fluid applications. The published recommended working pressure represent the capability of the subject fitting. Nevertheless, in some instances, the hose, hose fitting or other connector assembled to the adapter may dictate the maximum working pressure. The end-user should read and understand the Parker Safety Guide (Bulletin 4400-B.1) and follow its suggested practices and warnings.

## Permeability coefficient

$$\text{Permeability Coefficient} = \frac{V}{A \times T \times p}$$

Where: V is the volume of gas, in cm<sup>3</sup>, which diffuses through a 1mm thickness.

A is the area across which the gas diffuses, in m<sup>2</sup>.

T is the diffusion time, in days.

p is the pressure difference across the plastic, in bar.

Permeability Coefficients per DIN 53380

Material	Gas				
	N <sub>2</sub>	O <sub>2</sub>	CO <sub>2</sub>	H <sub>2</sub>	He
PTFE	50	150	1500	—	3500
PVDF	3	2	10	—	60
PA-6 XE 3289	1	4	10	100*	60*
PA-6 A 28 NZ	0.5	2	5	50*	30*
PA-12 L 2124	—	30	180	210	160
PA-12 P40 TL	—	—	105	—	—
PA-12 L 25W40	8	35	150	1000*	500*
PA-12 L 2140	—	12	71	—	130
PA-11 P 40 TL	—	—	55	130	—
PA-11 POTL	2	20	65	65	—
POM H 2320	5	10	130	35	40
POM 150 SA	2	4	20	—	—
PEE 4055	150	—	3000	—	1400
PEE 5556	120	—	1600	—	900
PEE 7246	—	—	—	—	300

\* Calculated value. Diffusion constants based on normal room temperature. Actual behavior may vary considerably because of variations in processing the plastic.

## Recommended tightening procedures

Connection	Thread sizes	Tightening torque	
		ft•lb	N•m
<b>High Pressure</b>			
1/4"	9/16" - 18	25	34
3/8"	3/4" - 16	50	69
9/16"	1-1/8" - 12	75	103
<b>Medium Pressure</b>			
1/4"	7/16" - 20	20	28
3/8"	9/16" - 18	30	41
9/16"	13/16" - 16	85	117
3/4"	3/4" NPSM	90	124
1"	1-3/8" - 12	125	173
<b>Type "M" Swivel</b>			
A9	9/16" - 18	25-30	34-41
A12	3/4" - 16	40-50	55-69
A14	7/8" - 14	50-60	69-83
A16	1" - 12	75-85	103-117
A21	1-5/16" - 12	100-120	138-166

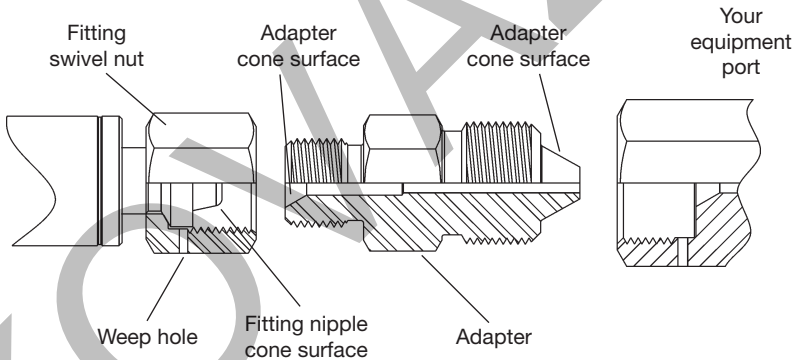

### Leakage at swivel nut-to-adapter Joint (Seen by leak at weep hole in swivel nut)

1. Reduce system pressure to zero
2. Unscrew swivel nut and check cone surfaces of adapter and hose insert.
3. If hose insert is damaged, return hose to **polyflex** for repair and retest.
4. If cone surfaces look good after cleaning, re-tighten swivel nut. Do not exceed 150% of recommended torque.

### Leakage at type "M" adapter-to-port

(Seen by leak at weep hole in pressure port, or leak at threads for NPT adapters.)

1. Reduce system pressure to zero.
2. Slacken hose swivel nut.
3. Tighten adaptor into port.
4. Re-tighten swivel nut.

Never use the swivel nut to tighten the adapter into the port.



## Metric conversion chart

	English to Metric			Metric to English		
	To Convert From	To	Multiply	To Convert From	To	Multiply
Area	sq. in. (in <sup>2</sup> )	sq. mm (mm <sup>2</sup> )	645.16	sq. mm (mm <sup>2</sup> )	sq. in. (in <sup>2</sup> )	0.00155
	sq. in. (in <sup>2</sup> )	sq. cm (cm <sup>2</sup> )	6.4516			
	sq. ft. (ft <sup>2</sup> )	sq. meters (m <sup>2</sup> )	0.0929			
Density	pounds/cubic foot (lb/ft <sup>3</sup> )	Kilograms/cubic meter (kg/m <sup>3</sup> )	16.02	Kilograms/cubic meter (kg/m <sup>3</sup> )	pounds/cubic foot (lb/ft <sup>3</sup> )	0.0624
Energy	British Thermal Units (Btu) (1 J = Ws = 0.2388 cal)	joules (J)	1055	joules (J)	British Thermal Units (Btu)	0.000947
Force	pounds - force (lbf) (1N = 0.102 kgf)	newtons (N)	4.448	newtons (N)	pounds - force (lbf)	0.2248
Length	inches (in)	millimeters (mm)	25.4	millimeters (mm)	inches (in)	0.03937
	feet (ft)	meters (m)	0.3048	meters (m)	feet (ft)	3.281
	miles (mi)	kilometers (km)	1.609	kilometers (km)	miles (mi)	0.621
Mass (Weight)	ounces (oz.)	grams (g)	28.35	grams (g)	ounces (oz.)	0.035
	pounds - mass (lb)	kilograms (kg)	0.4536	kilograms (kg)	pounds - mass (lb)	2.205
	short tons (2000 lb) (tn)	metric tons (1000 kg)	0.9072	metric tons (1000 kg)	short tons (2000 lb) (tn)	1.102
Power	horsepower (550 ft. lb/s) (hp)	kilowatts (kW)	0.7457	kilowatts (kW)	horsepower (550 ft. lb/s) (hp)	1.341
Pressure	pounds/square inch (psi)	kilograms (f)/square cm (kgf/cm <sup>2</sup> )	0.0703	kilograms (f)/square cm (kgf/cm <sup>2</sup> )	pounds/square inch (psi)	14.22
	pounds/square inch (psi)	kilopascals (kPa)	6.8948	kilopascals (kPa)	pounds/square inch (psi)	0.145
	pounds/square inch (psi)	bars (100 kPa)	0.06895	bars (100 kPa)	pounds/square inch (psi)	14.503
Stress	pounds/square inch (psi) (1N/mm <sup>2</sup> = 1MPa)	megapascals (MPa)	0.006895	megapascals (MPa)	pounds/square inch (psi)	145.039
Temperature	degrees Fahrenheit (°F)	degrees Celsius (°C)	5/9 (after subtracting 32)	degrees Celsius (°C)	degrees Fahrenheit (°F)	9/5 (then add 32)
Torque or Bending Moment	pounds-force-foot (lb-ft)	Newtons-meter (Nm)	1.3567	Newtons-meter (Nm)	pounds-force-foot (lb-ft)	0.737
	pounds-force-inch (lb-in)	Newtons-meter (Nm)	0.113	Newtons-meter (Nm)	pounds-force-inch (lb-in)	8.85
Velocity	feet/seconds (ft/s)	meters/second (m/S)	0.3048	meters/second (m/S)	feet/seconds (ft/s)	3.2808
Viscosity	dynamic (centipoise)	Pascal-second (Pas)	0.001	Pascal-second (Pas)	dynamic (centipoise)	1000
	kenematic-foof/sec (ft <sup>2</sup> /s)	meter <sup>2</sup> /sec (m <sup>2</sup> /s)	0.0929	meter <sup>2</sup> /sec (m <sup>2</sup> /s)	kenematic-foof/sec (ft <sup>2</sup> /s)	10.7643
Volume	cubic inch (in <sup>3</sup> )	cubic centimeter (cm <sup>3</sup> ) (milliliter)	16.3871	cubic centimeter (cm <sup>3</sup> ) (milliliter)	cubic inch (in <sup>3</sup> )	0.061
	quarts (qt)	liters (1000 cm <sup>3</sup> )	0.9464	liters (1000 cm <sup>3</sup> )	quarts (qt)	1.057
	gallons (gal)	liters	3.7854	liters	gallons (gal)	0.2642

## General chemical resistance table

### Ratings code

- G – Good to excellent. Little or no swelling, tensile or surface changes. Preferred choice.
- L – Marginal or conditional. Noticeable effects but not necessarily indicating lack of serviceability. Further testing suggested for specific application. Very long-term effects such as stiffening or potential for crazing should be evaluated.
- P – Poor or unsatisfactory. Not recommended without extensive and realistic testing.
- – Indicates that this was not tested.

### Materials code for hose core tubes

- N Polyamide
- M Coextruded tube with Fluoropolymer inner liner

### Materials code for hose cover

- N Polyamide
- U/HF Polyurethane

### Notes on the chemical resistance table

- (1) The fluid resistance tables are simplified rating tabulations based on immersion tests at 24° C. Higher temperatures tend to reduce ratings. Since final selection depends on pressure, fluid and ambient temperature and other factors not known to Parker Hannifin, no performance guarantee is expressed or implied. The indications do not imply any compliance with standards and regulations and do not refer to possible changes of colour, taste or smell. For food and drinking water specially approved materials have to be used. For fluids not listed or for advice on particular applications, please consult Parker Hannifin GmbH, **polyflex** Division in Hüttenfeld, Germany.
- (2) Hose applications for these fluids must take into account legal and insurance regulations. The chemical resistance indicated does not express or imply approval by certain institutions.
- (3) Satisfactory at some concentrations and temperatures, unsatisfactory at others.
- (4) For gas applications, the cover should be pin-pricked and the pressure must not be released quickly. Special safety guard accessories are to be used to prevent damage or personal injury in the event of failure..
- (5) Chemical resistance does not imply low permeation rates. Please consult Parker Hannifin for a recommendation for your specific requirements.
- (6) The indication of chemical resistance does not imply any special food compatibility; it refers only to the chemical resistance of the material.
- (7) Chemical resistance does not imply acceptability for use in airless paintspray applications. These applications require a special, electrically conductive hose.

Not all remarks may apply to Oil&Gas products

Chemical	N	U/HF	M
Acetone	G	P	L
Acetylene	--	--	--
Air (4)	G	G	G
Ammonium Chloride	P	G	G
Ammonium Hydroxyde	G	P	G
Anhydrous Ammonia	P	P	--
Aniline	P	P	G
Aromatic Hydrocarbons	G	L	--
Asphalt	G	G	L
Benzene	G	L	G
Butane (2) (4)	G	L	--
Calcium Chloride	--	G	G
Carbon Dioxide (4)	G	G	--
Carbon Monoxide (4)	--	G	--
Carbon Tetrachloride	G	P	G
Chlorinated Hydrocarbon Base Fluids	G	L	--
Chlorinated Petroleum Oil	G	L	--
Chlorinated Solvents	--	P	--
Chlorine, Gaseous, Dry	P	P	--
Chromic Acid	--	P	L
Citric Acid Solutions	G	L	G
Crude Petroleum Oil	G	G	--
Cyclohexan (2)	G	G	G
Diesel Fuel (2)	G	G	--
Diester Oils	G	P	--
Ethanol (6)	G	L	--
Ethers	G	P	G
Ethylene Glycol	G	L	G
Ethylene Oxide	G	L	--
Fatty Acids	G	--	G
Formaldehyde	L	P	G
Formic Acid J	P	P	G
Fuel Oil (2)	G	L	G
Gas (Oil) (2)	G	G	
Gasoline	G	--	G
Glycerine	G	L	G

**General chemical resistance table**

Chemical	N	U/HF	M
Glycols (to 135 °F)	G	L	G
Grease (petroleum base)	G	G	--
Hexane (2)	G	G	G
Hydraulic Fluid (petroleum base)	G	G	L
Hydraulic Fluid phosphate ester base)	G	L	--
Hydraulic Fluid water base)	G	G	--
Hydraulic oil (petroleum base)	G	G	L
Hydrochloric Acid	L	P	G
Hydrofluoric Acid	P	P	G
Hydrolube (hydraulic fluid/water glycol base)	G	L	--
IRUS 902 (hydraulic fluid/water-oil emulsion)	G	G	--
Isooctane (2)	G	G	G
Kerosene (2)	G	L	G
Ketones	G	P	G
Lime (calcium oxide)	G	G	G
Lindol (hydraulic fluid/phosphate esters)	G	P	--
LP-Gas	--	--	--
Lubricating Oils (diester base)	G	P	--
Lubricating Oils (petroleum base)	G	G	G
Methane	--	--	--
Methanol	G	P	--
Methyl Alcohol (6)	G	P	G
Methyl Ethyl Ketone (MEK)	G	P	G
Methyl Ethyl Ketone Peroxide (MEKP)	L	P	--
Methyl Isobutyl Ketone (MIBK)	G	P	G
Methylen Chloride	L	P	G
Mineral Oil	G	G	G
Mineral Spirits	--	L	--
Motor Oils	G	G	G
Naphta	G	P	G
Natural Gas (4)	--	--	--
Nitric Acid	P	P	L
Nitrobenzene	G	P	G
Nitrogen, Gaseous (4) (5)	G	G	G
Nitrous Oxide	L	--	--
Oil (SAE)	G	G	--

Technical information

Chemical	N	U/HF	M
Oxygen, Gaseous (4) (5) (6)	G	G	G
Pentane (2)	G	L	G
Perchloric Acid	P	P	L
Petroleum Ether	--	--	--
Petroleum Oils	G	G	--
Phenols	P	P	--
Phosphate Esters (above 135 °F)	G	P	--
Phosphate Esters (to 135 °F)	G	P	--
Propane (4) (5)	--	--	--
Propylen Glycol	--	G	G
Salt Water	--	--	G
Silicone Greases	G	G	--
Silicone Oils	G	G	--
Sodium Borate	G	G	G
Sodium Carbonate	--	--	--
Sodium Chloride Solutions	G	G	G
Sodium Hydroxide, 50%	P	P	G
Sodium Hypochloride	P	P	G
Steam	P	P	G
Straight Synthetic Oils (phosphate esters)	G	P	--
Sulphur Dioxide	L	L	G
Sulphur Hexafluoride Gas (4) (5)	G	G	--
Sulphuric Acid	P	P	--
Toluol, Toluene	G	L	G
Trichlorethylene	L	P	G
Ucon (hydraulic fluid/water glycol base)	G	L	--
Water (above 60 °C) (6)	G	P	L
Water (to 60 °C) (6)	G	G	G
Water Glycols (above 60 °C)	L	P	--
Water Glycols (to 60 °C)	G	L	--
Water in oil Emulsions (above 60 °C)	L	P	--
Water in oil Emulsions (to 60 °C)	G	L	--
Xylene	G	P	G
Zinc Chloride	G	G	G

# Parker Safety Guide

## For selecting and using Hose, Tubing, Fittings, and Related Accessories



**Parker Safety Guide for Selecting and Using Hose, Tubing, Fittings and Related Accessories**  
Publication No. 4400-B.1  
Revised: November 2007

**WARNING:** Failure or improper selection or improper use of hose, tubing, fittings, assemblies or related accessories ("Products") can cause death, personal injury and property damage. Possible consequences of failure or improper selection or improper use of these Products include but are not limited to:

- Fittings thrown off at high speed.
- High velocity fluid discharge.
- Explosion or burning of the conveyed fluid.
- Electrocutation from high voltage electric powerlines.
- Contact with suddenly moving or falling objects that are controlled by the conveyed fluid.

- Injections by high-pressure fluid discharge.
- Dangerously whipping Hose.
- Contact with conveyed fluids that may be hot, cold, toxic or otherwise injurious.
- Sparking or explosion caused by static electricity buildup or other sources of electricity.
- Sparking or explosion while spraying paint or flammable liquids.
- Injuries resulting from inhalation, ingestion or exposure to fluids.

Before selecting or using any of these Products, it is important that you read and follow the instructions below. Only Hose from Parker's Stratoflex Products Division is approved for in flight aerospace applications.

### 1.0 GENERAL INSTRUCTIONS

**1.1 Scope:** This safety guide provides instructions for selecting and using (including assembling, installing, and maintaining) these Products. For convenience, all rubber and/or thermoplastic products commonly called "hose" or "tubing" are called "Hose" in this safety guide. All assemblies made with Hose are called "Hose Assemblies". All products commonly called "fittings", "couplings" or "adapters" are called "Fittings". All related accessories (including crimping and swaging machines and tooling) are called "Related Accessories". This safety guide is a supplement to and is to be used with the specific Parker publications for the specific Hose, Fittings and Related Accessories that are being considered for use. Parker publications are available at [www.parker.com](http://www.parker.com). SAE J1273 ([www.sae.org](http://www.sae.org)) and ISO 17165 2 ([www.ansi.org](http://www.ansi.org)) also provide recommended practices for hydraulic Hose Assemblies.

**1.2 Fail-Safe:** Hose, Hose Assemblies and Fittings can and do fail without warning for many reasons. Design all systems and equipment in a fail safe mode, so that failure of the Hose, Hose Assembly or Fitting will not endanger persons or property.

**1.3 Distribution:** Provide a copy of this safety guide to each person responsible for selecting or fitting Hose and Fitting products. Do not select or use Parker Hose or Fittings without thoroughly reading and understanding this safety guide as well as the specific Parker publications for the Products.

**1.4 User Responsibility:** Due to the wide variety of operating conditions and applications for Hose and Fittings, Parker does not represent or warrant that any particular Hose or Fitting is suitable for any specific end use system. This safety guide does not analyze all technical parameters that must be considered in selecting a product. The user, through its own analysis and testing, is solely responsible for:

- Making the final selection of the Products.
- Assuring that the user's requirements are met and that the application presents no health or safety hazards.
- Providing all appropriate health and safety warnings on the equipment on which the Products are used.
- Assuring compliance with all applicable government and industry standards.

**1.5 Additional Questions:** Call the appropriate Parker technical service department if you have any questions or require any additional information. See the Parker publication for the Products being considered or used, or call 1 800 CPARKER, or go to [www.parker.com](http://www.parker.com), for telephone numbers of the appropriate technical service department.

### 2.0 HOSE AND FITTING SELECTION INSTRUCTIONS

**2.1 Electrical Conductivity:** Certain applications require that the Hose be nonconductive to prevent electrical current flow. Other applications require the Hose and the Fittings and the Hose/Fitting interface to be sufficiently

conductive to drain off static electricity. Extreme care must be exercised when selecting Hose and Fittings for these or any other applications in which electrical conductivity or nonconductivity is a factor.

The electrical conductivity or nonconductivity of Hose and Fittings is dependent upon many factors and may be susceptible to change. These factors include but are not limited to the various materials used to make the Hose and the Fittings, Fitting finish (some Fitting finishes are electrically conductive while others are nonconductive), manufacturing methods (including moisture control), how the Fittings contact the Hose, age and amount of deterioration or damage or other changes, moisture content of the Hose at any particular time, and other factors.

The following are considerations for electrically nonconductive and conductive Hose. For other applications consult the individual catalog pages and the appropriate industry or regulatory standards for proper selection.

**2.1.1 Electrically Nonconductive Hose:** Certain applications require that the Hose be nonconductive to prevent electrical current flow or to maintain electrical isolation. For applications that require Hose to be electrically nonconductive, including but not limited to applications near high voltage electric lines, only special nonconductive Hose can be used. The manufacturer of the equipment in which the nonconductive Hose is to be used must be consulted to be certain that the Hose and Fittings that are selected are proper for the application. Do not use any Parker Hose or Fittings for any such application requiring nonconductive Hose, including but not limited to applications near high voltage electric lines, unless (i) the application is expressly approved in the Parker technical publication for the product, (ii) the Hose is marked "nonconductive", and (iii) the manufacturer of the equipment on which the Hose is to be used specifically approves the particular Parker Hose and Fittings for such use.

**2.1.2 Electrically Conductive Hose:** Parker manufactures special Hose for certain applications that require electrically conductive Hose.

Parker manufactures special Hose for conveying paint in airless paint spraying applications. This Hose is labeled "Electrically Conductive Airless Paint Spray Hose" on its layline and packaging. This Hose must be properly connected to the appropriate Parker Fittings and properly grounded in order to dissipate dangerous static charge buildup, which occurs in all airless paint spraying applications. Do not use any other Hose for airless paint spraying, even if electrically conductive. Use of any other Hose or failure to properly connect the Hose can cause a fire or an explosion resulting in death, personal injury, and property damage.

Parker manufactures a special Hose for certain compressed natural gas ("CNG") applications where static electricity buildup may occur. Parker CNG Hose assemblies comply with the requirements of ANSI/IAS NGV 4.2-1999; CSA 12.52-M99, "Hoses for Natural Gas Vehicles and Dispensing Systems" ([www.ansi.org](http://www.ansi.org)). This Hose is labeled "Electrically Conductive for CNG Use" on its layline and packaging. This Hose must be properly connected to the appropriate Parker Fittings and properly grounded in order to dissipate

## Safety Guide

**2.2 Pressure:** Hose selection must be made so that the published maximum working pressure of the Hose and Fittings are equal to or greater than the maximum system pressure. The maximum working pressure of a Hose Assembly is the lower of the respective published maximum working pressures of the Hose and the Fittings used. Surge pressures or peak transient pressures in the system must be below the published maximum working pressure for the Hose. Surge pressures and peak pressures can usually only be determined by sensitive electrical instrumentation that measures and indicates pressures at millisecond intervals. Mechanical pressure gauges indicate only average pressures and cannot be used to determine surge pressures or peak transient pressures. Published burst pressure ratings for Hose is for manufacturing test purposes only and is no indication that the Product can be used in applications at the burst pressure or otherwise above the published maximum recommended working pressure.

**2.3 Suction:** Hoses used for suction applications must be selected to insure that the Hose will withstand the vacuum and pressure of the system. Improperly selected Hose may collapse in suction application.

**2.4 Temperature:** Be certain that fluid and ambient temperatures, both steady and transient, do not exceed the limitations of the Hose. Temperatures below and above the recommended limit can degrade Hose to a point where a failure may occur and release fluid. Properly insulate and protect the Hose Assembly when routing near hot objects (e.g. manifolds). Do not use any Hose in any application where failure of the Hose could result in the conveyed fluids (or vapors or mist from the conveyed fluids) contacting any open flame, molten metal, or other potential fire ignition source that could cause burning or explosion of the conveyed fluids or vapors.

**2.5 Fluid Compatibility:** Hose Assembly selection must assure compatibility of the Hose tube, cover, reinforcement, and Fittings with the fluid media used. See the fluid compatibility chart in the Parker publication for the product being considered or used. This information is offered only as a guide. Actual service life can only be determined by the end user by testing under all extreme conditions and other analysis. Hose that is chemically compatible with a particular fluid must be assembled using Fittings and adapters containing likewise compatible seals.

**2.6 Permeation:** Permeation (that is, seepage through the Hose) will occur from inside the Hose to outside when Hose is used with gases, liquid and gas fuels, and refrigerants (including but not limited to such materials as helium, diesel fuel, gasoline, natural gas, or LPG). This permeation may result in high concentrations of vapors which are potentially flammable, explosive, or toxic, and in loss of fluid. Dangerous explosions, fires, and other hazards can result when using the wrong Hose for such applications. The system designer must take into account the fact that this permeation will take place and must not use Hose if this permeation could be hazardous. The system designer must take into account all legal, government, insurance, or any other special regulations which govern the use of fuels and refrigerants. Never use a Hose even though the fluid compatibility is acceptable without considering the potential hazardous effects that can result from permeation through the Hose Assembly.

Permeation of moisture from outside the Hose to inside the Hose will also occur in Hose assemblies, regardless of internal pressure. If this moisture permeation would have detrimental effects (particularly, but not limited to refrigeration and air conditioning systems), incorporation of sufficient drying capacity in the system or other appropriate system safeguards should be selected and used.

**2.7 Size:** Transmission of power by means of pressurized fluid varies with pressure and rate of flow. The size of the components must be adequate to keep pressure losses to a minimum and avoid damage due to heat generation or excessive fluid velocity.

**2.8 Routing:** Attention must be given to optimum routing to minimize inherent problems (kinking or flow restriction due to Hose collapse, twisting of the Hose, proximity to hot objects or heat sources). For additional routing recommendations see SAE J1273 and ISO 17165-2. Hose Assemblies have a finite life and if possible, should be installed in a manner that allows for ease of inspection and future replacement. Rubber Hose because of its relative short life, should not be used in residential and commercial buildings for HVAC (heating, ventilating and air conditioning) applications.

**2.9 Environment:** Care must be taken to insure that the Hose and Fittings are either compatible with or protected from the environment (that is, surrounding conditions) to which they are exposed. Environmental conditions including but not limited to ultraviolet radiation, sunlight, heat, ozone, moisture, water, salt water, chemicals and air pollutants can cause degradation and premature failure.

**2.10 Mechanical Loads:** External forces can significantly reduce Hose life or cause failure. Mechanical loads which must be considered include excessive flexing, twist, kinking, tensile or side loads, bend radius, and vibration. Use of swivel type Fittings or adapters may be required to insure no twist is put into the Hose. Unusual applications may require special testing prior to Hose selection.

**2.11 Physical Damage:** Care must be taken to protect Hose from wear, snagging, kinking, bending smaller than minimum bend radius and cutting, any of which can cause premature Hose failure. Any Hose that has been kinked or bent to a radius smaller than the minimum bend radius, and any Hose that has been cut or is cracked or is otherwise damaged should be removed and discarded.

**2.12 Proper End Fitting:** See instructions 3.2 through 3.5. These recommendations may be substituted by testing to industry standards such as SAE J517 for hydraulic applications, or MIL-A-5070, AS1339, or AS3517 for Hoses from Parker's Stratoflex Products Division for aerospace applications.

**2.13 Length:** When establishing a proper Hose length, motion absorption, Hose length changes due to pressure, and Hose and machine tolerances and movement must be considered.

**2.14 Specifications and Standards:** When selecting Hose and Fittings, government, industry, and Parker specifications and recommendations must be reviewed and followed as applicable.

**2.15 Hose Cleanliness:** Hose components may vary in cleanliness levels. Care must be taken to insure that the Hose Assembly selected has an adequate level of cleanliness for the application.

**2.16 Fire Resistant Fluids:** Some fire resistant fluids that are to be conveyed by Hose require use of the same type of Hose as used with petroleum base fluids. Some such fluids require a special Hose, while a few fluids will not work with any Hose at all. See instructions 2.5 and 1.5. The wrong Hose may fail after a very short service. In addition, all liquids but pure water may burn fiercely under certain conditions, and even pure water leakage may be hazardous.

**2.17 Radiant Heat:** Hose can be heated to destruction without contact by such nearby items as hot manifolds or molten metal. The same heat source may then initiate a fire. This can occur despite the presence of cool air around the Hose.

**2.18 Welding or Brazing:** When using a torch or arc welder in close proximity to hydraulic lines, the hydraulic lines should be removed or shielded with appropriate fire resistant materials. Flame or weld spatter could burn through the Hose and possibly ignite escaping fluid resulting in a catastrophic failure. Heating of plated parts, including Hose Fittings and adapters, above 450°F (232°C) such as during welding, brazing or soldering may emit deadly gases.

**2.19 Atomic Radiation:** Atomic radiation affects all materials used in Hose assemblies. Since the long-term effects may be unknown, do not expose Hose assemblies to atomic radiation.

**2.20 Aerospace Applications:** The only Hose and Fittings that may be used for in flight aerospace applications are those available from Parker's Stratoflex Products Division. Do not use any other Hose or Fittings for in flight applications. Do not use any Hose or Fittings from Parker's Stratoflex Products Division with any other Hose or Fittings, unless expressly approved in writing by the engineering manager or chief engineer of Stratoflex Products Division and verified by the user's own testing and inspection to aerospace industry standards.

**2.21 Unlocking Couplings:** Ball locking couplings or other Fittings with quick disconnect ability can unintentionally disconnect if they are dragged over obstructions, or if the sleeve or other disconnect member, is bumped or moved enough to cause disconnect. Threaded Fittings should be considered where there is a potential for accidental uncoupling.

## Safety Guide

### 3.0 HOSE AND FITTING ASSEMBLY AND INSTALLATION INSTRUCTIONS

3.1 Component Inspection: Prior to assembly, a careful examination of the Hose and Fittings must be performed. All components must be checked for correct style, size, catalog number, and length. The Hose must be examined for cleanliness, obstructions, blisters, cover looseness, kinks, cracks, cuts or any other visible defects. Inspect the Fitting and sealing surfaces for burrs, nicks, corrosion or other imperfections. Do NOT use any component that displays any signs of nonconformance.

3.2 Hose and Fitting Assembly: Do not assemble a Parker Fitting on a Parker Hose that is not specifically listed by Parker for that Fitting, unless authorized in writing by the engineering manager or chief engineer of the appropriate Parker division. Do not assemble a Parker Fitting on another manufacturer's

Hose or a Parker Hose on another manufacturer's Fitting unless (i) the engineering manager or chief engineer of the appropriate Parker division approves the Assembly in writing or that combination is expressly approved in the appropriate Parker literature for the specific Parker product, and (ii) the user verifies the Assembly and the application through analysis and testing. For Parker Hose that does not specify a Parker Fitting, the user is solely responsible for the selection of the proper Fitting and Hose Assembly procedures. See instruction 1.4.

To prevent the possibility of problems such as leakage at the Fitting or system contamination, it is important to completely remove all debris from the cutting operation before installation of the Fittings. The Parker published instructions must be followed for assembling the Fittings on the Hose. These instructions are provided in the Parker Fitting catalog for the specific Parker Fitting being used, or by calling 1 800 CPARKER, or at [www.parker.com](http://www.parker.com).

3.3 Related Accessories: Do not crimp or swage any Parker Hose or Fitting with anything but the listed swage or crimp machine and dies in accordance with Parker published instructions. Do not crimp or swage another manufacturer's Fitting with a Parker crimp or swage die unless authorized in writing by the engineering manager or chief engineer of the appropriate Parker division.

3.4 Parts: Do not use any Parker Fitting part (including but not limited to socket, shell, nipple, or insert) except with the correct Parker mating parts, in accordance with Parker published instructions, unless authorized in writing by the engineering manager or chief engineer of the appropriate Parker division.

3.5 Field Attachable/Permanent: Do not reuse any field attachable Hose Fitting that has been blown or pulled off a Hose. Do not reuse a Parker permanent Hose Fitting (crimped or swaged) or any part thereof. Complete Hose Assemblies may only be reused after proper inspection under section 4.0. Do not assemble Fittings to any previously used hydraulic Hose that was in service, for use in a fluid power application.

3.6 Pre-Installation Inspection: Prior to installation, a careful examination of the Hose Assembly must be performed. Inspect the Hose Assembly for any damage or defects. DO NOT use any Hose Assembly that displays any signs of nonconformance.

3.7 Minimum Bend Radius: Installation of a Hose at less than the minimum listed bend radius may significantly reduce the Hose life. Particular attention must be given to preclude sharp bending at the Hose to Fitting juncture. Any bending during installation at less than the minimum bend radius must be avoided. If any Hose is kinked during installation, the Hose must be discarded.

3.8 Twist Angle and Orientation: Hose Assembly installation must be such that relative motion of machine components does not produce twisting.

3.9 Securement: In many applications, it may be necessary to restrain, protect, or guide the Hose to protect it from damage by unnecessary flexing, pressure surges, and contact with other mechanical components. Care must be taken to insure such restraints do not introduce additional stress or wear points.

3.10 Proper Connection of Ports: Proper physical installation of the Hose Assembly requires a correctly installed port connection insuring that no twist or torque is transferred to the Hose when the Fittings are being tightened or otherwise during use.

3.11 External Damage: Proper installation is not complete without insuring that tensile loads, side loads, kinking, flattening, potential abrasion, thread damage or damage to sealing surfaces are corrected or eliminated. See instruction 2.10.

3.12 System Checkout: All air entrapment must be eliminated and the system pressurized to the maximum system pressure (at or below the Hose maximum working pressure) and checked for proper function and freedom from leaks. Personnel must stay out of potential hazardous areas while testing and using.

3.13 Routing: The Hose Assembly should be routed in such a manner so if a failure does occur, the escaping media will not cause personal injury or property damage. In addition, if fluid media comes in contact with hot surfaces, open flame or sparks, a fire or explosion may occur. See section 2.4.

3.14 Ground Fault Equipment Protection Devices (GFEEDs): **WARNING! Fire and Shock Hazard:** To minimize the danger of fire if the heating cable of a Multitube bundle is damaged or improperly installed, use a Ground Fault Equipment Protection Device. Electrical fault currents may be insufficient to trip a conventional circuit breaker.

For ground fault protection, the IEEE 515:1989 ([www.ansi.org](http://www.ansi.org)) standard for heating cables recommends the use of GFEEDs with a nominal 30 milliamperere trip level for "piping systems in classified areas, those areas requiring a high degree of maintenance, or which may be exposed to physical abuse or corrosive atmospheres".

### 4.0 HOSE AND FITTING MAINTENANCE AND REPLACEMENT INSTRUCTIONS

4.1 Even with proper selection and installation, Hose life may be significantly reduced without a continuing maintenance program. The severity of the application, risk potential from a possible Hose failure, and experience with any Hose failures in the application or in similar applications should determine the frequency of the inspection and the replacement for the Products so that Products are replaced before any failure occurs. A maintenance program must be established and followed by the user and, at minimum, must include instructions 4.2 through 4.7.

4.2 Visual Inspection Hose/Fitting: Any of the following conditions require immediate shut down and replacement of the Hose Assembly:

- Fitting slippage on Hose;
- Damaged, cracked, cut or abraded cover (any reinforcement exposed);
- Hard, stiff, heat cracked, or charred Hose;
- Cracked, damaged, or badly corroded Fittings;
- Leaks at Fitting or in Hose;
- Kinked, crushed, flattened or twisted Hose; and
- Blistered, soft, degraded, or loose cover.

4.3 Visual Inspection All Other: The following items must be tightened, repaired, corrected or replaced as required:

- Leaking port conditions;
- Excess dirt buildup;
- Worn clamps, guards or shields; and
- System fluid level, fluid type, and any air entrapment.

4.4 Functional Test: Operate the system at maximum operating pressure and check for possible malfunctions and leaks. Personnel must avoid potential hazardous areas while testing and using the system. See section 2.2.

4.5 Replacement Intervals: Hose assemblies and elastomeric seals used on Hose Fittings and adapters will eventually age, harden, wear and deteriorate under thermal cycling and compression set. Hose Assemblies and elastomeric seals should be inspected and replaced at specific replacement intervals, based on previous service life, government or industry recommendations, or when failures could result in unacceptable downtime, damage, or injury risk. See section 1.2. Hose and Fittings may be subjected to internal mechanical and/or chemical wear from the conveying fluid and may fail without warning. The user must determine the product life under such circumstances by testing. Also see section 2.5. See section 1.2.



## Safety Guide

**4.6 Hose Inspection and Failure:** Hydraulic power is accomplished by utilizing high pressure fluids to transfer energy and do work. Hoses, Fittings and Hose Assemblies all contribute to this by transmitting fluids at high pressures. Fluids under pressure can be dangerous and potentially lethal and, therefore, extreme caution must be exercised when working with fluids under pressure and handling the Hoses transporting the fluids. From time to time, Hose Assemblies will fail if they are not replaced at proper time intervals. Usually these failures are the result of some form of misapplication, abuse, wear or failure to perform proper maintenance. When Hoses fail, generally the high pressure fluids inside escape in a stream which may or may not be visible to the user. Under no circumstances should the user attempt to locate the leak by "feeling" with their hands or any other part of their body. High pressure fluids can and will penetrate the skin and cause severe tissue damage and possibly loss of limb. Even seemingly minor hydraulic fluid injection injuries must be treated immediately by a physician with knowledge of the tissue damaging properties of hydraulic fluid.

If a Hose failure occurs, immediately shut down the equipment and leave the area until pressure has been completely released from the Hose Assembly. Simply shutting down the hydraulic pump may or may not eliminate the pressure in the Hose Assembly. Many times check valves, etc., are employed in a system and can cause pressure to remain in a Hose Assembly even when pumps or equipment are not operating. Tiny holes in the Hose, commonly known as pinholes, can eject small, dangerously powerful but hard to see streams of hydraulic fluid. It may take several minutes or even hours for the pressure to be relieved so that the Hose Assembly may be examined safely.

Once the pressure has been reduced to zero, the Hose Assembly may be taken off the equipment and examined. It must always be replaced if a failure has occurred. Never attempt to patch or repair a Hose Assembly that has failed. Consult the nearest Parker distributor or the appropriate Parker division for Hose Assembly replacement information.

Never touch or examine a failed Hose Assembly unless it is obvious that the Hose no longer contains fluid under pressure. The high pressure fluid is extremely dangerous and can cause serious and potentially fatal injury.

**4.7 Elastomeric seals:** Elastomeric seals will eventually age, harden, wear and deteriorate under thermal cycling and compression set. Elastomeric seals should be inspected and replaced.

**4.8 Refrigerant gases:** Special care should be taken when working with refrigeration systems. Sudden escape of refrigerant gases can cause blindness if the escaping gases contact the eye and can cause freezing or other severe injuries if it contacts any other portion of the body.

**4.9 Compressed natural gas (CNG):** Parker CNG Hose Assemblies should be tested after installation and before use, and at least on a monthly basis per ANSI/IAS NGV 4.2-1999; CSA 12.52-M99 Section 4.2 "Visual Inspection Hose/Fitting". The recommended procedure is to pressurize the Hose and check for leaks and to visually inspect the Hose for damage.

**Caution:** Matches, candles, open flame or other sources of ignition shall not be used for Hose inspection. Leak check solutions should be rinsed off after use.

### 5.0 HOSE STORAGE

**5.1 Age Control:** Hose and Hose Assemblies must be stored in a manner that facilitates age control and first-in and first-out usage based on manufacturing date of the Hose and Hose Assemblies. The shelf life of rubber Hose or Hose Assemblies that have passed visual inspection and a proof test is 10 years (40 quarters) from the date of manufacture. The shelf life of thermoplastic and polytetrafluoroethylene Hose or Hose Assemblies is considered to be unlimited.

**5.2 Storage:** Stored Hose and Hose Assemblies must not be subjected to damage that could reduce their expected service life and must be placed in a cool, dark and dry area with the ends capped. Stored Hose and Hose Assemblies must not be exposed to temperature extremes, ozone, oils, corrosive liquids or fumes, solvents, high humidity, rodents, insects, ultraviolet light, electromagnetic fields or radioactive materials.



**Chapter H**

**Index of part numbers**

Index ..... H-2

KOVANZ.CZ

## Index of part numbers

Part number	page	Part number	page
02Y5-12-12C	E-15	1018X-2-025	B-11
02Y5-12-16C	E-15	1018X-2-04	B-19, B-28
02Y5-12-4C	E-15	1018X-4-025	B-11
02Y5-12-6C	E-15	1018X-4-04	B-28
02Y5-12-9C	E-15	1018X-4-04C	B-28
02Y5-16-12C	E-15	1018X-4-04ZE	B-26
02Y5-16-16C	E-15	1018X-4-05	B-19
02Y5-16-6C	E-15	1018X-4-05C	B-19
02Y5-16-9C	E-15	1018X-6-04C	B-28
02Y5-2-12C	E-15	1018X-6-04ZE	B-26
02Y5-2-16C	E-15	1018X-6-05	B-19
02Y5-2-4C	E-15	1018X-6-05C	B-19
02Y5-2-6C	E-15	1018X-6-06	B-11
02Y5-2-9C	E-15	1018X-6-06C	B-19
02Y5-4-12C	E-15	1018X-6-4	B-28
02Y5-4-16C	E-15	1018X-8-06	B-11
02Y5-4-4C	E-15	1018X-8-06C	B-19
02Y5-4-6C	E-15	1018X-8-08	B-11
02Y5-4-9C	E-15	1018X-8-08C	B-19
02Y5-6-12C	E-15	101BL-12-12	C-31
02Y5-6-16C	E-15	101BL-6-06	C-31
02Y5-6-4C	E-15	101BL-6-06ZE	B-34
02Y5-6-6C	E-15	101BL-8-08	C-31
02Y5-6-9C	E-15	101BL-8-08C	C-31
02Y5-8-12C	E-15	101BL-8-08ZE	B-34
02Y5-8-16C	E-15	101BS-8-08	C-28
02Y5-8-4C	E-15	101BS-8-08C	C-28
02Y5-8-6C	E-15	101KY-4-04	C-24
02Y5-8-8C	E-15	101KY-4-04C	C-24
02Y6-12-6C	E-29	101KY-4-05	C-24
02Y6-12-9C	E-29	101KY-6-04	C-24
02Y6-16-9C	E-29	101KY-6-04C	C-24
02Y6-2-4C	E-29	101KY-6-05	C-24
02Y6-2-6C	E-29	101LX-12-12	C-41
02Y6-2-9C	E-29	101LX-16-16	C-41
02Y6-4-4C	E-29	101LX-2-025	C-41
02Y6-4-6C	E-29	101LX-2-04	C-41
02Y6-4-9C	E-29	101LX-4-03	C-41
02Y6-6-4C	E-29	101LX-4-04	C-41
02Y6-6-6C	E-29	101LX-4-04C	C-41
02Y6-6-9C	E-29	101LX-4-05	C-41
02Y6-8-4C	E-29	101LX-4-05C	C-41
02Y6-8-6C	E-29	101LX-6-04	C-41
02Y6-8-9C	E-29	101LX-6-05	C-41
1018X-1-04	B-19, B-28	101LX-6-05C	C-41

Part number	page	Part number	page
101LX-6-06	C-41	106TX-4-02W	C-10
101LX-8-06	C-41	106TX-6-03W	C-10
101LX-8-06C	C-41	106TX-6-04W	C-10
101LX-8-08	C-41	1078X-4-04	B-22, B-31
101LX-8-08C	C-41	1078X-4-04C2W	B-22, B-31
101TX-1-025W	C-12	1078X-6-05	B-22
101TX-1-02W	C-12	1078X-6-05C2W	B-22
101TX-2-025W	C-12	1078X-6-06	B-13, B-22
101TX-2-02W	C-12	1078X-6-06C	B-13
101TX-2-03W	C-12	1078X-6-06C2W	B-13, B-22
101TX-4-025W	C-12	1078X-8-08	B-13
101TX-4-03W	C-12	1078X-8-08C	B-13
101TX-4-04W	C-12	1078X-8-08C2W	B-13
101TX-4-05W	C-12	10C8X-12-06	B-8
101TX-6-05W	C-12	10C8X-14-06	B-8
102TX-1-025W	C-12	10C8X-16-08	B-8
102TX-2-03W	C-12	10K0101-12-12C	E-39
102TX-4-04W	C-12	10K0101-16-16C	E-39
1038X-10-08	B-12	10K0202-12-12C	E-37
1038X-6-06	B-12	10K0202-16-16C	E-37
1038X-8-06	B-12	10KL02-12C	E-37
1038X-8-08	B-12	10KL02-16C	E-37
103NX-24-20	B-12	10KT02-12C	E-38
1058X-4-04	B-20, B-28	10KT02-16C	E-38
1058X-6-04	B-20, B-28	10KX02-12C	E-38
1063X-6-06C	B-3	10KX02-16C	E-38
1068X-10-08	B-12	1158X-8-08	B-14
1068X-4-025	B-12	115NX-20-20	B-14
1068X-4-04C	B-29	1178X-8-08	B-15
1068X-4-4	B-3, B-29	117NX-20-20	B-15
1068X-5-04	B-3, B-29	1198X-8-08	B-15
1068X-5-04C	B-29	119NX-20-20	B-15
1068X-6-025	B-12	11C8X-14-06	B-8
1068X-6-04C	B-3, B-29	11C8X-16-08	B-8
1068X-6-05	B-20	13B8X-4-025	B-11, B-23
1068X-6-05C	B-20	13B8X-4-04	B-23, B-32
1068X-6-06	B-12	13B8X-6-04	B-23, B-32
1068X-6-06C	B-12, B-20	13B8X-6-05	B-23
1068X-6-4	B-29	13B8X-6-06	B-11, B-23
1068X-8-05	B-20	13B8X-8-06	B-11, B-23
1068X-8-06	B-12	13B8X-8-08	B-11
1068X-8-08	B-12	13BNX-24-20	B-11, B-23
1068X-8-08C	B-12	15K0101-1-1C	E-39
106NX-20-20	B-12	15K0101-2-2C	E-39
106TX-4-025W	C-10	15K0101-4-4C	E-39

Part number	page	Part number	page
15K0101-6-6C	E-39	192BS-8-08	C-28
15K0101-8-8C	E-39	192BS-8-08C	C-28
15K0201-1-8C	E-39	192EH-12-12	C-3, C-6
15K0201-2-8C	E-39	192EH-16-16	C-3, C-6
15K0201-4-8C	E-39	192EH-20-20	C-3, C-6
15K0201-6-8C	E-39	192EH-8-08	C-3, C-6
15K0202-2-2C	E-37	192KX-4-04W	C-26
15K0202-4-4C	E-37	192KX-6-05W	C-26
15K0202-6-6C	E-37	192KX-6-06W	C-17
15K0202-8-8C	E-37	192KY-6-05	C-21
15KL02-4C	E-37	192LX-12-08C	C-38
15KL02-6C	E-37	192LX-16-12	C-38
15KL02-8C	E-37	192LX-16-12C4462	C-38
15KT02-4C	E-38	192LX-20-16	C-38
15KT02-6C	E-38	192LX-4-03	C-38
15KT02-8C	E-38	192LX-4-03C	C-38
15KX02-4C	E-38	192LX-6-05	C-38
15KX02-6C	E-38	192LX-6-05C	C-38
15KX02-8C	E-38	192LX-8-06	C-38
16A8X-8-08	B-16	192LX-8-06C	C-38
16ANX-20-20	B-16	192LX-8-08	C-38, B-21
16F8X-8-08	B-16	192LX-8-08C	C-38, B-21
16FNX-20-20	B-16	192LX-8-08W	C-17
16N8X-8-08	B-17	1AY2X-10-05	C-51, C-64, C-71
16NNX-20-20	B-17	1AY2X-13-05	C-51, C-64, C-71
16Y2X-4-025	C-52, C-64	1AY2X-6-025	C-51, C-64
16Y2X-4-03	C-52, C-64	1AY2X-6-03	C-51, C-64, C-71
1922X-4-025	C-52, C-65	1AY2X-8-05	C-51, C-64, C-71
1922X-4-03	C-52, C-65	1AY5X-11-08	C-54
1923X-8-06C	B-3	1AY5X-16-12	C-54
1925X-4-3	C-55	1AY5X-6-03	C-54
1928X-4-025	B-9, B-21	1AY8X-6-025	B-14
1928X-4-04	B-21, B-29	1AY8X-6-04	B-22, B-30
1928X-4-04C	B-21, B-29	1AY8X-8-05	B-22
1928X-6-04C	B-3	1AY8X-8-06	B-22
1928X-6-06	B-9, B-21	1AYBL-11-06	C-32
1928X-6-06C	B-21	1AYBL-11-08	C-32
1928X-8-06	B-9, B-21	1AYBL-11-08C	C-32
1928X-8-06C	B-21	1AYBS-11-08	C-29
1928X-8-08	B-9	1AYBS-11-08C	C-29
192BC-8-06	C-31	1AYCX-16-16W	C-57
192BL-16-12	C-31	1AYJX-11-08W	C-51
192BL-6-06	C-31	1AYJX-16-12W	C-51, C-57
192BL-8-08	C-31	1AYKX-6-04W	C-26
192BL-8-08C	C-31	1AYKX-8-05W	C-26

Part number	page	Part number	page
1AYKX-8-06W	C-18	1C95X-25-12	C-54
1AYKY-6-04	C-22	1C98X-10-04	B-32
1AYKY-6-04C	C-22	1C98X-10-04C	B-4, B-32
1AYKY-8-05	C-22	1C98X-12-04	B-24
1AYLX-11-08	C-18, C-36	1C98X-12-05	B-24
1AYLX-11-08C	C-36	1C98X-12-06	B-7
1AYLX-16-12	C-36	1C98X-12-06C	B-24
1AYLX-16-12C4462	C-36	1C98X-14-06	B-7
1AYLX-6-02	C-36	1C98X-14-06C	B-24
1AYLX-6-025	C-36	1C98X-16-05	B-24
1AYLX-6-03	C-36	1C98X-16-08	B-7
1AYLX-6-03C	C-36	1C98X-8-025	B-7
1AYLX-6-04	C-36	1C98X-8-025C	B-24
1AYLX-6-04C	C-36	1C98X-8-04	B-32
1AYLX-8-05	C-36	1C98X-8-04C	B-4, B-32
1AYLX-8-05C	C-36	1C9BL-14-06	C-32
1AYLX-8-06	C-36	1C9BL-14-08	C-32
1AYLX-8-06C	C-36	1C9BL-14-08C	C-32
1AYTX-6-025W	C-10	1C9BL-16-06	C-32
1AYTX-6-02W	C-10	1C9BL-16-08	C-32
1AYTX-6-03W	C-10	1C9BL-16-08C	C-32
1AYTX-6-04W	C-10	1C9BL-25-12	C-32
1AYTX-8-05W	C-10	1C9BS-14-08	C-28
1C35X-8-03	C-54	1C9BS-14-08C	C-28
1C38X-10-06	B-6	1C9BS-16-08	C-28
1C38X-10-06C2W	B-6	1C9BS-16-08C	C-28
1C38X-12-06	B-6	1C9CX-30-16W	C-57
1C38X-12-06C2W	B-6	1C9JX-16-08W	C-51
1C38X-12-08	B-6	1C9JX-25-12W	C-51, C-57
1C38X-12-08C2W	B-6	1C9JX-30-16W	C-51
1C38X-15-08	B-6	1C9KX-10-04W	C-26
1C38X-15-08C2W	B-6	1C9KX-14-06W	C-17
1C38X-8-06	B-6	1C9KX-16-05W	C-26
1C3LX-8-025	C-39	1C9KY-10-04	C-21
1C3LX-8-03	C-39	1C9KY-10-04C	C-21
1C3LX-8-03C	C-39	1C9KY-12-05	C-21
1C3LX-8-04	C-39	1C9KY-14-05	C-21
1C3LX-8-04C	C-39	1C9KY-16-04	C-21
1C68X-14-06	B-7	1C9KY-16-04C	C-21
1C68X-16-08	B-7	1C9KY-16-05	C-21
1C6LX-12-04	C-40	1C9LX-10-04	C-35
1C6LX-12-05	C-40	1C9LX-12-05	C-35
1C92X-12-05	C-51, C-66	1C9LX-12-06	C-35
1C93X-14-06C	B-4	1C9LX-14-03	C-35
1C95X-16-08	C-54	1C9LX-14-05	C-35

Part number	page	Part number	page
1C9LX-14-06	C-35	1D9LX-4-05	C-39
1C9LX-14-06C	C-35	1D9LX-4-06	C-39
1C9LX-16-03	C-35	1MR2X	C-53
1C9LX-16-04	C-35	1MR2X-12-03	C-53
1C9LX-16-05	C-35	1MR2X-8-03	C-53
1C9LX-16-05C	C-35	1MRLX-6-03	C-40
1C9LX-16-06	C-35	1MRLX-8-03	C-40
1C9LX-16-06C	C-35	1TM2X-8-03-HPK	C-53, C-66, C-71
1C9LX-16-08	B-24, C-17, C-35	1TM2X-8-05-HPK	C-53, C-66, C-71
1C9LX-16-08C	C-35	1TMBL-9-08-HPK	C-32
1C9LX-25-12	C-35	1TMBS-8-05-HPK	C-24
1C9LX-25-12C4462	C-35	1TMBS-9-08-HPK	C-29
1C9LX-30-16	C-35	1U08X-4-04	B-31
1C9LX-8-025	C-35	1U08X-4-04C2W	B-31
1C9NX-38-20	B-7	1U08X-6-04	B-31
1C9TX-10-04W	C-11	1U08X-6-04C2W	B-31
1C9TX-12-05W	C-11	1U08X-6-05	B-23
1C9TX-14-05W	C-11	1U08X-6-05C2W	B-23
1C9TX-16-025W	C-11	1U08X-6-06	B-10
1C9TX-16-02W	C-11	1U08X-6-06C2W	B-10
1C9TX-16-03W	C-11	1U08X-8-06	B-10
1C9TX-16-04W	C-11	1U08X-8-06C2W	B-10
1C9TX-16-05W	C-11	1U08X-8-08	B-10
1D28X-12-06	B-9	1U08X-8-08C2W	B-10
1D28X-14-06	B-9	1U0KY-4-04	C-23
1D28X-16-08	B-9	1U0KY-4-04C	C-23
1D2NX-38-20	B-9	1U0NX-24-20	B-10
1D98X-4-025	B-21	1U0TX-2-02W	C-11
1D98X-4-025C	B-21	1U0TX-4-025W	C-11
1D98X-4-04C	B-21, B-30	1U0TX-4-02W	C-11
1D98X-4-4	B-21, B-30	1U0TX-4-03W	C-11
1D98X-6-04C	B-21	1U0TX-4-04W	C-11
1D98X-6-05	B-21	1U0TX-6-05W	C-11
1D98X-6-06	B-21	1Y2CX-16-16W	C-57
1D98X-6-06C	B-21	1Y2JX-16-12W	C-52
1D98X-8-08	B-21	1Y2JX-16-16W	C-52
1D9EH-12-12	C-3, C-6	1Y2LX-12-08C	C-45
1D9EH-16-16	C-3, C-6	1Y2LX-12-12C4462	C-45
1D9EH-20-20	C-3, C-6	1Y2LX-3-04C	C-45
1D9EH-8-08	C-3, C-6	1Y2LX-6-025	C-45
1D9KY-4-04	C-23	1Y2LX-6-03	C-45
1D9KY-4-04C	C-23	1Y2LX-6-04	C-45
1D9LX-4-025	C-39	1Y2LX-9-05	C-45
1D9LX-4-03	C-39	1Y2LX-9-06C	C-45
1D9LX-4-04	C-39	1Y2LX-9-08	C-45



Part number	page	Part number	page
1Y42X-4-025	C-50, C-63	1YHTX-4-025W-LH	C-15
1Y42X-4-03	C-50, C-63	1YHTX-6-03W	C-15
1Y42X-6-025	C-50, C-63	1YHTX-6-03W-LH	C-15
1Y42X-6-03	C-50, C-63, C-70	1YHTX-6-04W	C-15
1Y42X-6-04	C-50	1YHTX-6-04W-LH	C-15
1Y42X-6-05	C-50, C-63, C-70	1YHTX-6-05W	C-15
1Y42X-9-03	C-50, C-63, C-70	1YHTX-6-05W-LH	C-15
1Y42X-9-04	C-50	1YM2X-6-025	C-50, C-63
1Y42X-9-05	C-50, C-63, C-70	1YM2X-6-03	C-50, C-63, C-70
1Y4KY-9-05	C-22	1YM2X-6-04	C-50
1Y9LX-4-03	C-38	1YM2X-6-05	C-50, C-63, C-70
1Y9LX-4-03C	C-38	1YMJX-11-08W	C-50
1Y9LX-6-05	C-38	1YMJX-12-08W	C-50
1Y9LX-8-08	C-38	1YMKY-6-05	C-22
1YA5X-1-03	C-55	1YMLX-11-08	C-36
1YA5X-3-03	C-55	1YMLX-11-12C4462	C-36
1YALX-1-025	C-37	1YMLX-6-025	C-36
1YALX-1-025C	C-37	1YMLX-6-05	C-36
1YALX-1-03	C-37	1YZTX-1-025W	C-14
1YALX-1-03C	C-37	1YZTX-1-02WS	C-14
1YALX-3-025	C-37	1YZTX-2-025W	C-14
1YALX-3-03	C-37	1YZTX-2-02W	C-14
1YALX-3-03C	C-37	1YZTX-2-03W	C-14
1YALX-3-04	C-37	1YZTX-4-025W	C-14
1YALX-3-05C	C-37	1YZTX-4-03W	C-14
1YALX-6-03	C-37	1YZTX-5-025W	C-14
1YALX-6-03C	C-37	1YZTX-5-04W	C-14
1YALX-6-04	C-37	1YZTX-5-05W	C-14
1YALX-6-05	C-37	2022N-04V15-10K	B-2
1YALX-6-05C	C-37	2022N-06V15-10K	B-2
1YALX-6-06	C-37	216-200-18	F-2
1YBKY-4-04	C-24	220-200-22	F-2
1YBKY-4-04C	C-24	2240D-025V32-TC	C-8
1YBKY-4-05	C-24	2240D-02V32-TC	C-8
1YBKY-6-05	C-24	2240D-03V32-TC	C-8
1YBTX-2-025W	C-15	2240D-04V32-TC	C-8
1YBTX-2-02W	C-15	2244N-025V00	B-5
1YBTX-2-03W	C-15	2244N-06V00	B-5
1YBTX-2-04W	C-15	2244N-06V10W	C-16
1YBTX-4-025W	C-15	2244N-08V10	B-5
1YBTX-4-03W	C-15	2244N-08V10W	C-16
1YBTX-4-04W	C-15	2244N-20V30	B-5
1YBTX-4-05W	C-15	2248D-025V32-TC	C-9
1YBTX-6-05W	C-15	2248D-03V32-TC	C-9
1YHTX-4-025W	C-15	2248D-05V32-TC	C-9

Part number	page	Part number	page
2380M-04V30W	C-25	2740D-05V34	C-58
2380M-05V30W	C-25	2740D-08V30	C-58
2380N-025V10	B-18	2741D-05V34/10	C-59
2380N-04V00W	C-19	2748D-05V34	C-60, C-61
2380N-04V10-MSHA	B-25	2749D-03V34	C-62
2380N-05V00	B-18	2749D-05V34	C-62
2380N-05V00W	C-19	2840D-03V34	C-67
2380N-06V10	B-18	2840D-05V36	C-67
2380N-08V10	B-18	2840D-08V30	C-67
2380N-20V30	B-18	2841D-05V36/17	C-68
2388N-04V00	B-27	2848D-05V34	C-69
2388N-04V12W	C-20	2848D-08V30	C-69
2388N-08V12W	C-27	2849D-05V34	C-72
2440D-025V32	C-33	292EJ-12-12	C-7
2440D-025V32-TC	C-34	292EJ-16-16	C-7
2440D-02V32	C-33	292EJ-20-20	C-7
2440D-03V32	C-33	292EJ-8-08	C-7
2440D-03V32-TC	C-34	292NC-12-12	C-4
2440D-04V32	C-33	292NC-16-16	C-4
2440D-04V32-TC	C-34	292NC-20-20	C-4
2440D-05V32	C-33	292NC-8-08	C-4
2440D-05V32-TC	C-34	2D9EJ-12-12	C-7
2440N-06V30	C-33	2D9EJ-16-16	C-7
2440N-06V30-TC	C-34	2D9EJ-20-20	C-7
2440N-08V30	C-33	2D9EJ-8-08	C-7
2440N-08V30-TC	C-34	2D9NC-12-12	C-4
2440N-12V30	C-33	2D9NC-16-16	C-4
2440N-16V30	C-33	2D9NC-20-20	C-4
2448D-025V32-TC	C-46	2D9NC-8-08	C-4
2580N-06V10-MSHA	B-33	508-J-500-10	F-2
2580N-06V12	C-30	510-A-500-12	F-2
2580N-08V10-MSHA	B-33	520-A-500-26	F-2
2580N-08V12	C-30	5Y01-12-12C	E-14
2580N-12V12	C-30	5Y01-12-16C	E-14
2640D-025V32	C-49	5Y01-12-2C	E-14
2640D-03V32	C-49	5Y01-12-4C	E-14
2640D-04V32	C-49	5Y01-12-6C	E-14
2640D-05V32	C-49	5Y01-12-8C	E-14
2640N-08V32	C-49	5Y01-16-12C	E-14
2640N-12V32	C-49	5Y01-16-16C	E-14
2640N-16V32	C-49	5Y01-16-2C	E-14
2648N-12V32	C-56	5Y01-16-4C	E-14
2648N-16V32	C-56	5Y01-16-6C	E-14
2740D-025V16	C-58	5Y01-16-8C	E-14
2740D-03V34	C-58	5Y01-4-12C	E-14

Part number	page	Part number	page
5Y01-4-16C	E-14	5Y02-9-6C	E-18
5Y01-4-2C	E-14	5Y02-9-8C	E-18
5Y01-4-4C	E-14	5Y5Y-12-12C	E-16
5Y01-4-6C	E-14	5Y5Y-12-16C	E-16
5Y01-4-8C	E-14	5Y5Y-16-16C	E-16
5Y01-6-12C	E-14	5Y5Y-4-12C	E-16
5Y01-6-16C	E-14	5Y5Y-4-16C	E-16
5Y01-6-2C	E-14	5Y5Y-4-4C	E-16
5Y01-6-4C	E-14	5Y5Y-4-6C	E-16
5Y01-6-6C	E-14	5Y5Y-4-9C	E-16
5Y01-6-8C	E-14	5Y5Y-6-12C	E-16
5Y01-9-12C	E-14	5Y5Y-6-16C	E-16
5Y01-9-16C	E-14	5Y5Y-6-6C	E-16
5Y01-9-2C	E-14	5Y5Y-6-9C	E-16
5Y01-9-4C	E-14	5Y5Y-9-12C	E-16
5Y01-9-6C	E-14	5Y5Y-9-16C	E-16
5Y01-9-8C	E-14	5Y5Y-9-9C	E-16
5Y02-12-12C	E-18	5Y6Y-12-4C	E-17
5Y02-12-16C	E-18	5Y6Y-12-6C	E-17
5Y02-12-2C	E-18	5Y6Y-12-9C	E-17
5Y02-12-4C	E-18	5Y6Y-16-4C	E-17
5Y02-12-6C	E-18	5Y6Y-16-6C	E-17
5Y02-12-8C	E-18	5Y6Y-16-9C	E-17
5Y02-16-12C	E-18	5Y6Y-4-4C	E-17
5Y02-16-16C	E-18	5Y6Y-4-6C	E-17
5Y02-16-2C	E-18	5Y6Y-4-9C	E-17
5Y02-16-4C	E-18	5Y6Y-6-4C	E-17
5Y02-16-6C	E-18	5Y6Y-6-6C	E-17
5Y02-16-8C	E-18	5Y6Y-6-9C	E-17
5Y02-4-12C	E-18	5Y6Y-9-4C	E-17
5Y02-4-16C	E-18	5Y6Y-9-6C	E-17
5Y02-4-2C	E-18	5Y6Y-9-9C	E-17
5Y02-4-4C	E-18	5YY5-12-16C	E-11
5Y02-4-6C	E-18	5YY5-12-4C	E-11
5Y02-4-8C	E-18	5YY5-12-6C	E-11
5Y02-6-12C	E-18	5YY5-12-9C	E-11
5Y02-6-16C	E-18	5YY5-16-12C	E-11
5Y02-6-2C	E-18	5YY5-16-4C	E-11
5Y02-6-4C	E-18	5YY5-16-6C	E-11
5Y02-6-6C	E-18	5YY5-16-9C	E-11
5Y02-6-8C	E-18	5YY5-4-12C	E-11
5Y02-9-12C	E-18	5YY5-4-16C	E-11
5Y02-9-16C	E-18	5YY5-4-6C	E-11
5Y02-9-2C	E-18	5YY5-4-9C	E-11
5Y02-9-4C	E-18	5YY5-6-12C	E-11

Part number	page	Part number	page
5YY5-6-4C	E-11	6HYLX-6-3C-PL	C-43
5YY5-6-9C	E-11	6HYLX-6-3C-PL-LH	C-43
5YY5-9-12C	E-11	6HYLX-6-4C-PL	C-43
5YY5-9-16C	E-11	6HYLX-6-4C-PL-LH	C-43
5YY5-9-4C	E-11	6HYLX-9-5C-PL	C-43
5YY5-9-6C	E-11	6HYLX-9-5C-PL-LH	C-43
5YY6-12-4C	E-12	6HYPL-1-2	C-13
5YY6-12-6C	E-12	6Y01-4-12C	E-28
5YY6-12-9C	E-12	6Y01-4-16C	E-28
5YY6-16-6C	E-12	6Y01-4-2C	E-28
5YY6-16-9C	E-12	6Y01-4-4C	E-28
5YY6-4-4C	E-12	6Y01-4-6C	E-28
5YY6-4-6C	E-12	6Y01-4-8C	E-28
5YY6-4-9C	E-12	6Y01-6-12C	E-28
5YY6-6-4C	E-12	6Y01-6-16C	E-28
5YY6-6-6C	E-12	6Y01-6-2C	E-28
5YY6-6-9C	E-12	6Y01-6-4C	E-28
5YY6-9-4C	E-12	6Y01-6-6C	E-28
5YY6-9-6C	E-12	6Y01-6-8C	E-28
5YY6-9-9C	E-12	6Y01-9-12C	E-28
601LX-16-16C	C-41	6Y01-9-16C	E-28
612-400-14	F-2	6Y01-9-2C	E-28
620-100-18	F-2	6Y01-9-4C	E-28
63ZPL-5-2A	C-13	6Y01-9-6C	E-28
63ZPL-5-3	C-13	6Y01-9-8C	E-28
63ZPL-5-3C	C-13	6Y02-4-12C	E-32
63ZPL-5-4C	C-13	6Y02-4-16C	E-32
65YLX-6-3	C-44	6Y02-4-2C	E-32
65YLX-6-3C	C-44	6Y02-4-4C	E-32
65YLX-6-4	C-44	6Y02-4-6C	E-32
65YLX-6-4C	C-44	6Y02-4-8C	E-32
66YLX-4-3	C-44	6Y02-6-12C	E-32
66YLX-4-3C	C-44	6Y02-6-16C	E-32
692LX-16-16C	C-38	6Y02-6-2C	E-32
6AYLX-16-16C	C-36	6Y02-6-4C	E-32
6AYLX-6-2AC	C-36, C-48	6Y02-6-6C	E-32
6AYWX-10-5C-55	C-74	6Y02-6-8C	E-32
6C9LX-30-16C	C-35	6Y02-9-12C	E-32
6EZPL-1-2A	C-14	6Y02-9-16C	E-32
6EZPL-5-2A	C-14	6Y02-9-2C	E-32
6HYLX-4-2AC-PL	C-43, C-47	6Y02-9-4C	E-32
6HYLX-4-2AC-PL-LH	C-43, C-47	6Y02-9-6C	E-32
6HYLX-4-3C-PL	C-43	6Y02-9-8C	E-32
6HYLX-4-3C-PL-LH	C-43	6Y25X-12-8C	C-52
6HYLX-6-2AC-PL-LH	C-43, C-47	6Y25X-9-8C	C-52

Part number	page	Part number	page
6Y2LX-16-12C	C-45	6YY6-6-9C	E-27
6Y4HX-16-8C	C-63, C-65	6YY6-9-4C	E-27
6Y4LX-4-2AC	C-48	6YY6-9-9C	E-27
6Y4LX-6-2AC	C-48	6ZELX-5-3C	C-45
6Y4WX-16-8C	C-70	6ZEPL-5-2A	C-13
6Y4WX-9-5C-55	C-73	ESH-08	C-2
6Y6Y-4-4C	E-31	ESH-12	C-2
6Y6Y-4-6C	E-31	ESH-16	C-2
6Y6Y-4-9C	E-31	ESH-20	C-2
6Y6Y-6-6C	E-31	ESH250Plus-08	C-5
6Y6Y-6-9C	E-31	ESH250Plus-12	C-5
6Y6Y-9-9C	E-31	ESH250Plus-16	C-5
6YHLX-4-2AC-PL	C-42, C-47	ESH250Plus-20	C-5
6YHLX-4-2AC-PL-LH	C-42, C-47	HBPHM4-B	E-35
6YHLX-4-3C-PL	C-42	HBPHM6-B	E-35
6YHLX-4-3C-PL-LH	C-42	HBPHM9-B	E-35
6YHLX-6-3C-PL	C-42	HBPLM12-B	E-24
6YHLX-6-3C-PL-LH	C-42	HBPLM16-B	E-24
6YHLX-6-4C-PL	C-42	HBPLM4-B	E-24
6YHLX-6-4C-PL-LH	C-42	HBPLM6-B	E-24
6YHLX-9-5C-PL	C-42	HBPLM9-B	E-24
6YHLX-9-5C-PL-LH	C-42	HS-03	F-4
6YMHX-11-8C	C-63	HS-05	F-4
6YMHX-12-8C	C-63	HS-08	F-4
6YMWX-11-8C	C-70	HS-12	F-4
6YMWX-12-8C	C-70	HS-16	F-4
6YMWX-6-5C-55	C-73	KL-03	F-4
6YY5-4-12C	E-13	KL-05	F-4
6YY5-4-16C	E-13	KL-08	F-4
6YY5-4-4C	E-13	KL-12	F-4
6YY5-4-6C	E-13	KL-16	F-4
6YY5-4-9C	E-13	L5Y-4C	E-22
6YY5-6-12C	E-13	L5Y-6C	E-22
6YY5-6-16C	E-13	L5Y-9C	E-22
6YY5-6-4C	E-13	L5Y-12C	E-22
6YY5-6-6C	E-13	L5Y-16C	E-22
6YY5-6-9C	E-13	L6Y-4C	E-33
6YY5-9-12C	E-13	L6Y-6C	E-33
6YY5-9-16C	E-13	L6Y-9C	E-33
6YY5-9-4C	E-13	MHDC010	F-2
6YY5-9-6C	E-13	MHDC011	F-2
6YY5-9-9C	E-13	MHDC012	F-2
6YY6-4-6C	E-27	MHDC014	F-2
6YY6-4-9C	E-27	MHDC016	F-2
6YY6-6-4C	E-27	MHDC018	F-2

<b>Part number</b>	<b>page</b>	<b>Part number</b>	<b>page</b>
MHDC020	F-2	Y2C-16C	E-24
MHDC022	F-2	Y2N-4C	E-23
MHDC024	F-2	Y2N-6C	E-23
MHDC026	F-2	Y2N-9C	E-23
MHDC032	F-2	Y2N-12C	E-23
MK022-03-038	F-3	Y2N-16C	E-23
MK022-03-039	F-3	Y4N-4C	E-34
MK022-03-041	F-3	Y4N-6C	E-34
MK022-03-042	F-3	Y4N-9C	E-34
MK022-03-043	F-3	Y4NC-4C-AV	E-35
MK022-03-045	F-3	Y4NC-6C-AV	E-35
MSG060	F-3	Y4NC-9C-AV	E-35
MSG1006	F-3	Y5Y5-4-4C	E-19
MSG2006	F-3	Y5Y5-4-6C	E-19
MSG2106	F-3	Y5Y5-4-12C	E-19
MSG4113	F-3	Y5Y5-4-16C	E-19
MSG4120	F-3	Y5Y5-6-6C	E-19
MSG4125	F-3	Y5Y5-6-9C	E-19
MSG6020	F-3	Y5Y5-6-12C	E-19
PVC-S-03	F-4	Y5Y5-6-16C	E-19
PVC-S-05	F-4	Y5Y5-9-9C	E-19
PVC-S-08	F-4	Y5Y5-9-12C	E-19
PVC-S-12	F-4	Y5Y5-9-16C	E-19
PVC-S-16	F-4	Y5Y5-12-12C	E-19
T5Y-4C	E-22	Y5Y5-12-16C	E-19
T5Y-6C	E-22	Y5Y6-4-4C	E-20
T5Y-9C	E-22	Y5Y6-4-6C	E-20
T5Y-12C	E-22	Y5Y6-4-9C	E-20
T5Y-16C	E-22	Y5Y6-6-4C	E-20
T6Y-4C	E-33	Y5Y6-6-9C	E-20
T6Y-6C	E-33	Y5Y6-9-4C	E-20
T6Y-9C	E-33	Y5Y6-9-9C	E-20
UHPLABEL	F-4	Y5Y6-12-4C	E-20
X5Y-4C	E-23	Y5Y6-12-6C	E-20
X5Y-6C	E-23	Y5Y6-12-9C	E-20
X5Y-9C	E-23	Y5Y6-16-4C	E-20
X5Y-12C	E-23	Y5Y6-16-6C	E-20
X5Y-16C	E-23	Y5Y6-16-9C	E-20
X6Y-4C	E-34	Y6Y6-4-4C	E-30
X6Y-6C	E-34	Y6Y6-4-6C	E-30
X6Y-9C	E-34	Y6Y6-4-9C	E-30
Y2C-4C	E-24	Y6Y6-6-6C	E-30
Y2C-6C	E-24	Y6Y6-6-9C	E-30
Y2C-9C	E-24	Y6Y6-9-9C	E-30
Y2C-12C	E-24	Y204-0275C	E-25

Part number	page	Part number	page
Y204-0300C	E-25	Y501-4-8C	E-21
Y204-0400C	E-25	Y501-6-4C	E-21
Y204-0600C	E-25	Y501-6-6C	E-21
Y204-0800C	E-25	Y501-6-8C	E-21
Y204-1000C	E-25	Y501-9-2C	E-21
Y204-1200C	E-25	Y501-9-4C	E-21
Y206-0300C	E-25	Y501-9-6C	E-21
Y206-0400C	E-25	Y501-9-8C	E-21
Y206-0600C	E-25	Y501-9-12C	E-21
Y206-0800C	E-25	Y501-9-16C	E-21
Y206-1000C	E-25	Y501-12-2C	E-21
Y206-1200C	E-25	Y501-12-4C	E-21
Y209-0400C	E-25	Y501-12-6C	E-21
Y209-0600C	E-25	Y501-12-8C	E-21
Y209-0800C	E-25	Y501-12-12C	E-21
Y209-1000C	E-25	Y501-12-16C	E-21
Y209-1200C	E-25	Y501-16-2C	E-21
Y212-0400C	E-25	Y501-16-4C	E-21
Y212-0600C	E-25	Y501-16-6C	E-21
Y212-0800C	E-25	Y501-16-8C	E-21
Y212-1000C	E-25	Y501-16-12C	E-21
Y212-1200C	E-25	Y501-16-16C	E-21
Y216-0600C	E-25	Y601-4-2C	E-30
Y216-0800C	E-25	Y601-4-4C	E-30
Y216-1000C	E-25	Y601-4-6C	E-30
Y216-1200C	E-25	Y601-4-8C	E-30
Y404-0275C	E-35	Y601-4-12C	E-30
Y404-0300C	E-35	Y601-6-4C	E-30
Y404-0400C	E-35	Y601-6-6C	E-30
Y404-0600C	E-35	Y601-9-4C	E-30
Y404-0800C	E-35	Y601-9-6C	E-30
Y404-1000C	E-35	Y601-9-8C	E-30
Y404-1200C	E-35	Y601-9-12C	E-30
Y406-0300C	E-35	Y601-9-16C	E-30
Y406-0600C	E-35	YA01-6-2C	E-9
Y406-0800C	E-35	YA01-6-4C	E-9
Y406-1000C	E-35	YA01-6-6C	E-9
Y406-1200C	E-35	YA01-6-8C	E-9
Y409-0275C	E-35	YA01-8-4C	E-9
Y409-0400C	E-35	YA01-8-6C	E-9
Y409-0600C	E-35	YA01-8-8C	E-9
Y409-0800C	E-35	YA01-8-12C	E-9
Y409-1000C	E-35	YA01-8-16C	E-9
Y409-1200C	E-35	YA01-11-6C	E-9
Y501-4-4C	E-21	YA01-11-8C	E-9

<b>Part number</b>	<b>page</b>	<b>Part number</b>	<b>page</b>
YA01-11-12C.....	E-9	YAY5-6-4C.....	E-7
YA01-11-16C.....	E-9	YAY5-6-6C.....	E-7
YA01-16-8C.....	E-9	YAY5-6-12C.....	E-7
YA01-16-12C.....	E-9	YAY5-8-6C.....	E-7
YA01-16-16C.....	E-9	YAY5-8-12C.....	E-7
YA01-16-20C.....	E-9	YAY5-11-6C.....	E-7
YA01-16-24C.....	E-9	YAY5-11-12C.....	E-7
YA01-16-32C.....	E-9	YAY5-16-12C.....	E-7
YA02-6-4C.....	E-8	YAY6-6-4C.....	E-5
YA02-6-8C.....	E-8	YAY6-6-6C.....	E-5
YA02-8-8C.....	E-8	YAY6-6-9C.....	E-5
YA02-11-8C.....	E-8	YAY6-8-6C.....	E-5
YA6C-CAP.....	E-6	YAY6-8-9C.....	E-5
YA6C-PLUG.....	E-6	YAY6-10-6C.....	E-5
YA8C-CAP.....	E-6	YAY6-10-9C.....	E-5
YA8C-PLUG.....	E-6	YAY6-11-9C.....	E-5
YA11C-CAP.....	E-6	YAYA-6-6C.....	E-5
YA11C-PLUG.....	E-6	YAYA-8-6C.....	E-5
YA16C-CAP.....	E-6	YAYA-8-8C.....	E-5
YA16C-PLUG.....	E-6	YAYA-10-6C.....	E-5
YAY1-8-16C.....	E-7	YAYA-10-10C.....	E-5
YAY1-11-16C.....	E-7	YAYA-11-8C.....	E-5
YAY1-16-16C.....	E-7	YAYA-11-11C.....	E-5
YAY2-8-16C.....	E-7	YAYA-16-11C.....	E-5
YAY2-11-16C.....	E-7	YAYA-16-16C.....	E-5
YAY2-16-16C.....	E-7		

### For Your Safety

The hose assemblies listed in this catalogue are all special constructions with the hose having up to eight spiral layers of steel wire. Due to this construction, pressures are achieved which far exceed German and international standards. These hose types are manufactured and tested according to the Polyflex standards which have proved to be effective over many years.

Polyflex hose assemblies are used at considerable working pressures. The critical area of a hose assembly is the connection between flexible hose and rigid fitting (crimping area). Only the use of original Polyflex components (hose, fittings and tooling) and full compliance with the Polyflex assembly instructions can guarantee safety and conformity with standards. It is essential that training be given to customers in the hose assembly process in order to make high quality Polyflex maximum pressure hose assemblies.

For the production and testing of the hose assemblies relevant to the applications, the guidelines and technical regulations as well as the protection and hazard prevention rulings must be adhered to.

You as the manufacturer of Polyflex hose assemblies are obliged to mark these hose assemblies according to the regulations and to verify their safety by a final pressure test.

Non-compliance with these rules can lead to the premature failure of the hose assembly and the loss of warranty.









# Parker's Motion & Control Technologies

At Parker, we're guided by a relentless drive to help our customers become more productive and achieve higher levels of profitability by engineering the best systems for their requirements. It means looking at customer applications from many angles to find new ways to create value. Whatever the motion and control technology need, Parker has the experience, breadth of product and global reach to consistently deliver. No company knows more about motion and control technology than Parker. For further info call 00800 27 27 5374



## Aerospace

### Key Markets

- Airmarket services
- Commercial transports
- Engines
- General & business aviation
- Helicopters
- Launch vehicles
- Ways to aircraft
- Missiles
- Power generation
- Regional transports
- Unmanned aerial vehicles

### Key Products

- Control systems & actuation products
- Engine systems & components
- Fluid conveyance systems & components
- Fluid metering, delivery & atomization devices
- Fuel systems & components
- Fuel tank inerting systems
- Hydraulic systems & components
- Thermal management
- Wheels & brakes



## Climate Control

### Key Markets

- Agriculture
- Air conditioning
- Construction Machinery
- Food & beverage
- Industrial machinery
- Life sciences
- Oil & gas
- Precision cooling
- Process
- Refrigeration
- Transportation

### Key Products

- Accumulators
- Advanced actuators
- CO<sub>2</sub> controls
- Electronic controllers
- Filter driers
- Hand shut-off valves
- Heat exchangers
- Hose & fittings
- Pressure regulating valves
- Refrigerant distributors
- Safety relief valves
- Smart pumps
- Solenoid valves
- Thermostatic expansion valves



## Electromechanical

### Key Markets

- Aerospace
- Factory automation
- Life science & medical
- Machine tools
- Packaging machinery
- Paper machinery
- Plastics machinery & converting
- Primary metals
- Semiconductor & electronics
- Textile
- Wire & cable

### Key Products

- AC/DC drives & systems
- Electric actuators, gantry robots & slides
- Electrohydraulic actuation systems
- Electromechanical actuation systems
- Human machine interface
- Linear motors
- Slipper motors, servo motors, drives & controls
- Structural extrusions



## Filtration

### Key Markets

- Aerospace
- Food & beverage
- Industrial plant & equipment
- Life sciences
- Marine
- Mobile equipment
- Oil & gas
- Power generation & renewable energy
- Process
- Transportation
- Water Purification

### Key Products

- Analytical gas generators
- Compressed air filters & dryers
- Engine air, coolant, fuel & oil filtration systems
- Fluid condition monitoring systems
- Hydraulic & lubrication filters
- Hydrogen, nitrogen & zero air generators
- Instrumentation filters
- Membrane & fiber filters
- Microfiltration
- Sterile air filtration
- Water desalination & purification filters & systems



## Fluid & Gas Handling

### Key Markets

- Aerial lift
- Agriculture
- Bulk chemical handling
- Construction machinery
- Food & beverage
- Fuel & gas delivery
- Industrial machinery
- Life sciences
- Marine
- Mining
- Mobile
- Oil & gas
- Renewable energy
- Transportation

### Key Products

- Check valves
- Connectors for low pressure fluid conveyance
- Deep sea umbilicals
- Diagnostic equipment
- Hose couplings
- Industrial hose
- Mixing systems & power cables
- PTFE hose & tubing
- Quick couplings
- Rubber & thermoplastic hose
- Tube fittings & adapters
- Tubing & plastic fittings



## Hydraulics

### Key Markets

- Aerial lift
- Agriculture
- Alternative energy
- Construction machinery
- Forestry
- Industrial machinery
- Machine tools
- Marine
- Material handling
- Mining
- Oil & gas
- Power generation
- Refrill vehicles
- Renewable energy
- Truck hydraulics
- Turf equipment

### Key Products

- Electrohydraulic actuators
- Human machine interfaces
- Hybrid drives
- Hydraulic cylinders
- Hydraulic motors & pumps
- Hydraulic systems
- Hydraulic valves & controls
- Hydrostatic steering
- Integrated hydraulic circuits
- Power take-offs
- Power units
- Rotary actuators
- Sensors



## Pneumatics

### Key Markets

- Aerospace
- Conveying & material handling
- Factory automation
- Life science & medical
- Machine tools
- Packaging machinery
- Transportation & automotive

### Key Products

- Air preparation
- Boss fittings & valves
- Manifolds
- Pneumatic accessories
- Pneumatic actuators & grippers
- Pneumatic valves & controls
- Quick disconnects
- Rotary actuators
- Rubber & thermoplastic hose & couplings
- Structural extrusions
- Thermoplastic tubing & fittings
- Vacuum generators, cups & sensors



## Process Control

### Key Markets

- Alternative fuels
- Biopharmaceuticals
- Chemical & refining
- Food & beverage
- Marine & shipbuilding
- Medical & dental
- Microelectronics
- Nuclear Power
- Offshore oil exploration
- Oil & gas
- Pharmaceuticals
- Power generation
- Pulp & paper
- Steel
- Water/wastewater

### Key Products

- Analytical instruments
- Analytical sample conditioning products & systems
- Chemical injection fittings & valves
- Fluoropolymer chemical delivery fittings, valves & pumps
- High purity gas delivery fittings, valves, regulators & digital flow controllers
- Industrial mass flow meters/controllers
- Permanent non-weld tube fittings
- Precision industrial regulators & flow controllers
- Process control double block & bleed
- Process control fittings, valves, regulators & manifold valves



## Sealing & Shielding

### Key Markets

- Aerospace
- Chemical processing
- Consumer
- Fluid power
- General industrial
- Information technology
- Life sciences
- Microelectronics
- Military
- Oil & gas
- Power generation
- Renewable energy
- Telecommunications
- Transportation

### Key Products

- Dynamic seals
- Elastomeric o-rings
- Electro-medical instrument design & assembly
- EMI shielding
- Extruded & precision-cut, fabricated elastomeric seals
- High temperature metal seals
- Homogeneous & inserted elastomeric shapes
- Medical device fabrication & assembly
- Metal & plastic retained composite seals
- Shielded optical windows
- Silicone tubing & extrusions
- Thermal management
- Vibration dampening

ENGINEERING YOUR SUCCESS.

# Parker Worldwide

## Europe, Middle East, Africa

### AE – United Arab Emirates, Dubai

Tel: +971 4 8127100  
parker.me@parker.com

### AT – Austria, Wiener Neustadt

Tel: +43 (0)2622 23501-0  
parker.austria@parker.com

### AT – Eastern Europe, Wiener Neustadt

Tel: +43 (0)2622 23501 900  
parker.easteurope@parker.com

### AZ – Azerbaijan, Baku

Tel: +994 50 2233 458  
parker.azerbaijan@parker.com

### BE/LU – Belgium, Nivelles

Tel: +32 (0)67 280 900  
parker.belgium@parker.com

### BG – Bulgaria, Sofia

Tel: +359 2 980 1344  
parker.bulgaria@parker.com

### BY – Belarus, Minsk

Tel: +48 (0)22 573 24 00  
parker.poland@parker.com

### CH – Switzerland, Etoy

Tel: +41 (0)21 821 87 00  
parker.switzerland@parker.com

### CZ – Czech Republic, Klecany

Tel: +420 284 083 111  
parker.czechrepublic@parker.com

### DE – Germany, Kaarst

Tel: +49 (0)2131 4016 0  
parker.germany@parker.com

### DK – Denmark, Ballerup

Tel: +45 43 56 04 00  
parker.denmark@parker.com

### ES – Spain, Madrid

Tel: +34 902 330 001  
parker.spain@parker.com

### FI – Finland, Vantaa

Tel: +358 (0)20 753 2500  
parker.finland@parker.com

### FR – France, Contamine s/Arve

Tel: +33 (0)4 50 25 80 25  
parker.france@parker.com

### GR – Greece, Athens

Tel: +30 210 933 6450  
parker.greece@parker.com

### HU – Hungary, Budaörs

Tel: +36 23 885 470  
parker.hungary@parker.com

### IE – Ireland, Dublin

Tel: +353 (0)1 466 6370  
parker.ireland@parker.com

### IT – Italy, Corsico (MI)

Tel: +39 02 45 19 21  
parker.italy@parker.com

### KZ – Kazakhstan, Almaty

Tel: +7 7273 561 000  
parker.easteurope@parker.com

### NL – The Netherlands, Oldenzaal

Tel: +31 (0)541 585 000  
parker.nl@parker.com

### NO – Norway, Asker

Tel: +47 66 75 34 00  
parker.norway@parker.com

### PL – Poland, Warsaw

Tel: +48 (0)22 573 24 00  
parker.poland@parker.com

### PT – Portugal, Leca da Palmeira

Tel: +351 22 999 7360  
parker.portugal@parker.com

### RO – Romania, Bucharest

Tel: +40 21 252 1382  
parker.romania@parker.com

### RU – Russia, Moscow

Tel: +7 495 645-2156  
parker.russia@parker.com

### SE – Sweden, Spånga

Tel: +46 (0)8 59 79 50 00  
parker.sweden@parker.com

### SK – Slovakia, Banská Bystrica

Tel: +421 484 162 252  
parker.slovakia@parker.com

### SL – Slovenia, Novo Mesto

Tel: +386 7 337 6650  
parker.slovenia@parker.com

### TR – Turkey, Istanbul

Tel: +90 216 4997081  
parker.turkey@parker.com

### UA – Ukraine, Kiev

Tel: +48 (0)22 573 24 00  
parker.poland@parker.com

### UK – United Kingdom, Warwick

Tel: +44 (0)1926 317 878  
parker.uk@parker.com

### ZA – South Africa, Kempton Park

Tel: +27 (0)11 961 0700  
parker.southafrica@parker.com

## North America

### CA – Canada, Milton, Ontario

Tel: +1 905 693 3000

### US – USA, Cleveland

Tel: +1 216 896 3000

## Asia Pacific

### AU – Australia, Castle Hill

Tel: +61 (0)2-9634 7777

### CN – China, Shanghai

Tel: +86 21 2899 5000

### HK – Hong Kong

Tel: +852 2428 8008

### IN – India, Mumbai

Tel: +91 22 6513 7081-85

### JP – Japan, Tokyo

Tel: +81 (0)3 6408 3901

### KR – South Korea, Seoul

Tel: +82 2 559 0400

### MY – Malaysia, Shah Alam

Tel: +60 3 7849 0800

### NZ – New Zealand, Mt Wellington

Tel: +64 9 574 1744

### SG – Singapore

Tel: +65 6887 6300

### TH – Thailand, Bangkok

Tel: +662 186 7000

### TW – Taiwan, Taipei

Tel: +886 2 2298 8987

## South America

### AR – Argentina, Buenos Aires

Tel: +54 3327 44 4129

### BR – Brazil, Sao Jose dos Campos

Tel: +55 800 727 5374

### CL – Chile, Santiago

Tel: +56 2 623 1216

### MX – Mexico, Toluca

Tel: +52 72 2275 4200

## Parker Hannifin Manufacturing Germany GmbH & Co. KG

### polyflex Division

An der Tuchbleiche 4  
68623 Lampertheim (Hüttenfeld)  
Tel.: +49 (0)6256 81-0  
Fax: +49 (0)6256 81-123  
www.parker.com/polyflex  
polyflex@parker.com

